

Features

- Low drain-source on-resistance: $R_{DS(ON)}=0.23\Omega(\text{typ})$
- Easy to control gate switching
- Enhancement mode: $V_{th} = 2.0$ to $4.0V$
- 100% avalanche tested
- RoHS compliant

Key Performance Parameters



Parameter	Value	Unit
$V_{DS} @ T_{j,max}$	650	V
$R_{DS(ON),max}$	260	m Ω
I_D	15	A
$Q_{g,typ}$	27	nC
I_{DM}	45	A

Applications

- Switch Mode Power Supply (SMPS)
- Uninterruptible Power Supply (UPS)
- Power Factor Correction (PFC)
- Charger, Lighting

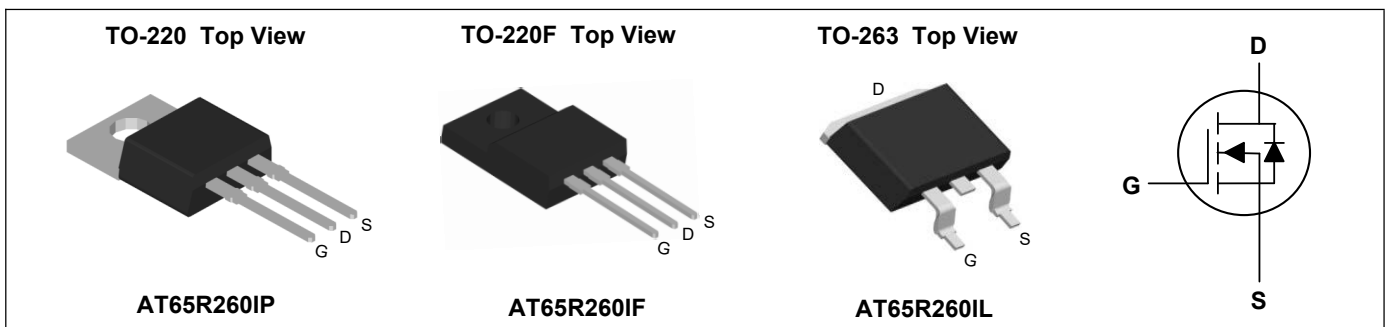

Absolute Maximum Ratings ($T_C=25^\circ\text{C}$, unless otherwise noted)

Parameter	Symbol	TO-220/TO-263	TO-220F	Unit
Drain-Source Voltage	V_{DS}	650		V
Gate-Source Voltage	V_{GS}	± 30		V
Continuous Drain Current ¹	I_D	15		A
Pulsed Drain Current ²	I_{DM}	45		A
Single Pulse Avalanche Energy ⁴	EAS	290		mJ
Avalanche Current	I_{AS}	2.4		A
Repetitive Avalanche energy, t_{AR} limited by T_{Jmax}	E_{AR}	0.44		mJ
MOSFET dv/dt ruggedness, $V_{DS} = 0 \dots 400V$	dv/dt	50		V/ns
Reverse diode dv/dt ³ $V_{DS}=0 \dots 400V, I_{sp} \leq I_D$		50		
Total Power Dissipation ($T_C=25^\circ\text{C}$)	P_D	100	31	W
Storage Temperature Range	T_{STG}	-55 to 150		$^\circ\text{C}$
Operating Junction Temperature Range	T_J	-55 to 150		$^\circ\text{C}$

Thermal Characteristics

Parameter	Symbol	TO-220/TO-263	TO-220F	Unit
Thermal Resistance Junction-Ambient	$R_{\theta JA}$	62	80	$^\circ\text{C/W}$
Thermal Resistance Junction-Case	$R_{\theta JC}$	1.6	4	$^\circ\text{C/W}$

Electrical Characteristics (T_J=25°C, unless otherwise noted)

Parameter	Symbol	Conditions	Min	Typ	Max	Unit
Drain-Source Breakdown Voltage	BV _{DSS}	V _{GS} =0V, I _D =250uA	650	---	---	V
Static Drain-Source On-Resistance	R _{DS(ON)}	V _{GS} =10V, I _D =7.5A	---	230	260	mΩ
Gate Threshold Voltage	V _{GS(th)}	V _{GS} =V _{DS} , I _D =250uA	2.0	---	4.0	V
Drain-Source Leakage Current	I _{DSS}	V _{DS} =650V, V _{GS} =0V, T _J =25°C	---	---	1	uA
		V _{DS} =650V, V _{GS} =0V, T _J =150°C	---	---	100	
Gate-Source Leakage Current	I _{GSS}	V _{GS} =±30V, V _{DS} =0V	---	---	±100	nA
Gate Resistance	R _G	f = 1.0MHz, open drain	---	12	---	Ω
Total Gate Charge	Q _g	V _{DD} =400V, V _{GS} =10V, I _D =15A	---	27	---	nC
Gate-Source Charge	Q _{gs}		---	5.5	---	
Gate-Drain Charge	Q _{gd}		---	10.5	---	
Turn-On Delay Time	T _{d(on)}	V _{DD} =400V, V _{GS} =10V, R _G =25Ω, I _D =15A	---	25	---	ns
Rise Time	T _r		---	65	---	
Turn-Off Delay Time	T _{d(off)}		---	105	---	
Fall Time	T _f		---	50	---	
Input Capacitance	C _{iss}	V _{DS} =100V, V _{GS} =0V, f=1MHz	---	1170	---	pF
Output Capacitance	C _{oss}		---	51	---	
Reverse Transfer Capacitance	C _{rss}		---	7	---	

Drain-Source Diode Characteristics

Parameter	Symbol	Conditions	Min	Typ	Max	Unit
Continuous Source Current	I _S	T _C =25°C	---	---	15	A
Pulsed Source Current	I _{SM}		---	---	45	A
Diode Forward Voltage	V _{SD}	V _G =0V, I _S =15A, T _J =25°C	---	0.9	1.2	V
Reverse Recovery Time	t _{rr}	V _R =400V, I _F =15A, di _F /dt=100A/μs	---	410	---	ns
Reverse Recovery Charge	Q _{rr}		---	4	---	uC
Peak Reverse Recovery Current	I _{rrm}		---	20	---	A

Note:

- Limited by T_{J,max}. Maximum Duty Cycle D = 0.50
- Pulse width t_p limited by T_{J,max}
- Identical low side and high side switch with identical R_G
- V_{DD}=50V, R_G=25Ω, I_{AS}=2.4A

Typical Characteristics

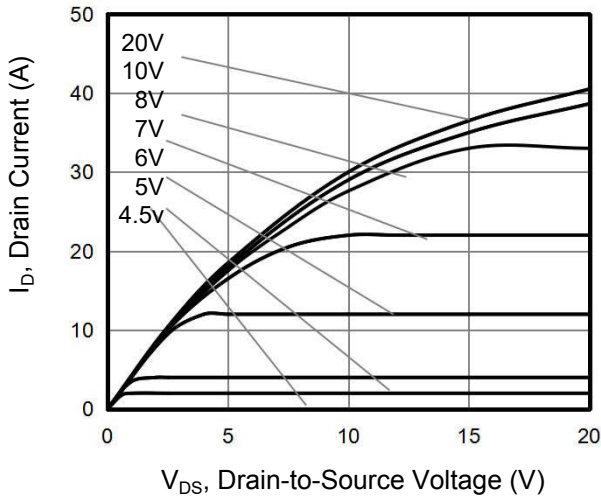

V_{DS} , Drain-to-Source Voltage (V)
Figure 1. Output Characteristics

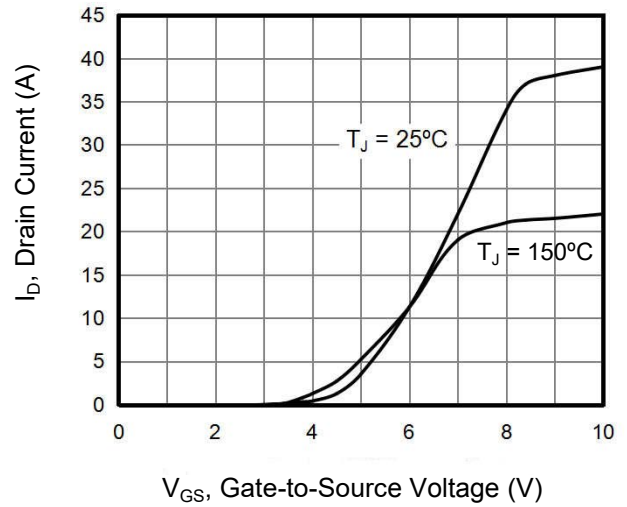

V_{GS} , Gate-to-Source Voltage (V)
Figure 2. Transfer Characteristics

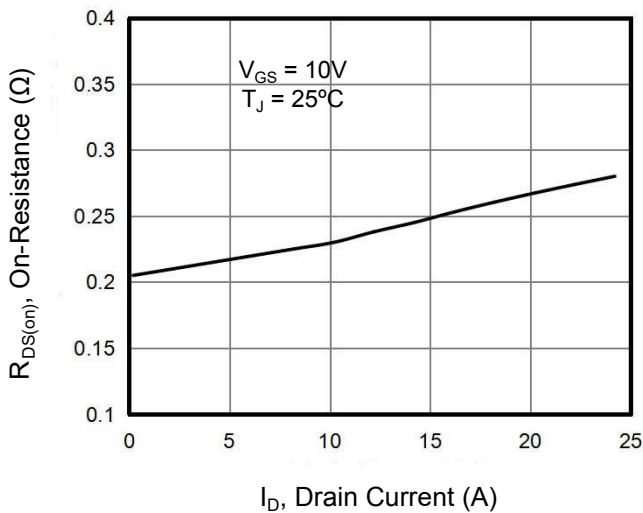

I_D , Drain Current (A)
Figure 3. On-Resistance vs. Drain Current

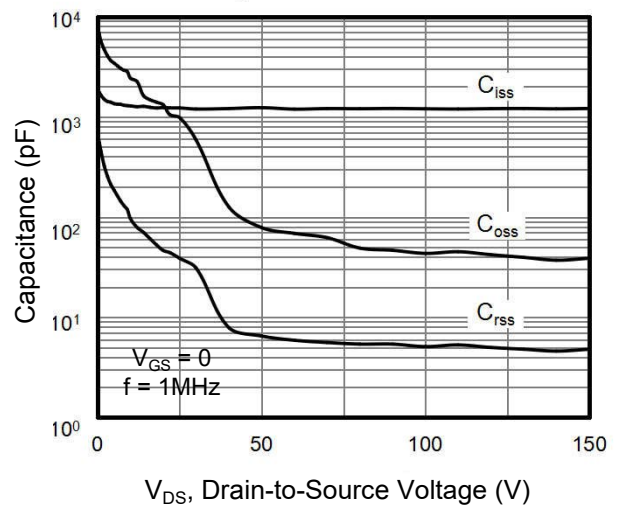

V_{DS} , Drain-to-Source Voltage (V)
Figure 4. Capacitance

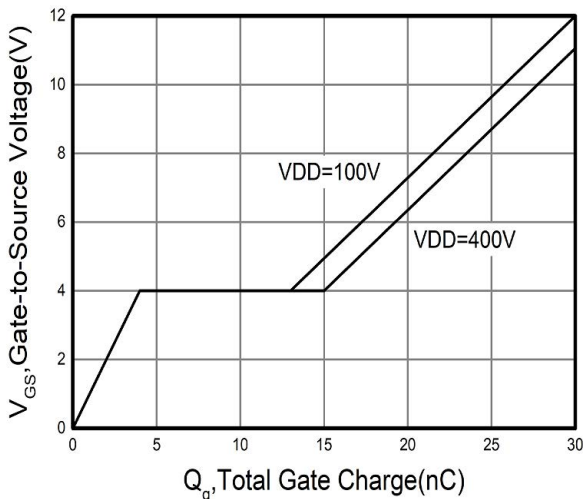
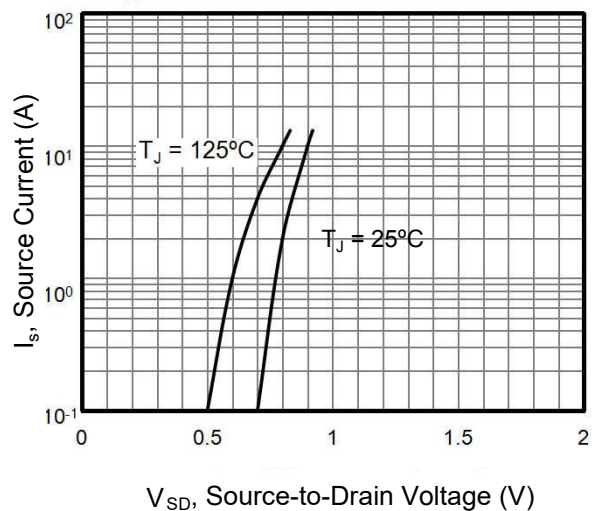

Figure 5. Gate Charge



V_{SD} , Source-to-Drain Voltage (V)
Figure 6. Body Diode Forward Voltage

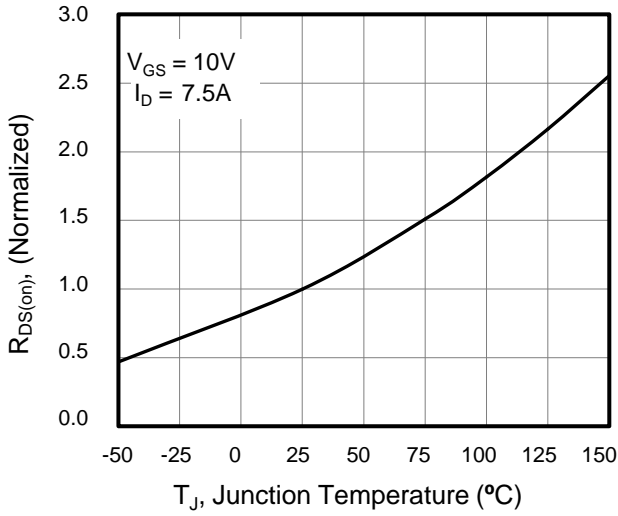

Figure 7. On-Resistance vs. Junction Temperature

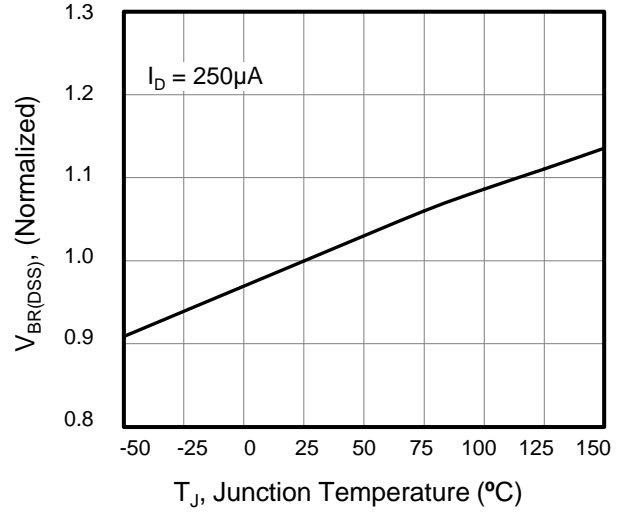

Figure 8. Breakdown voltage vs. Junction Temperature

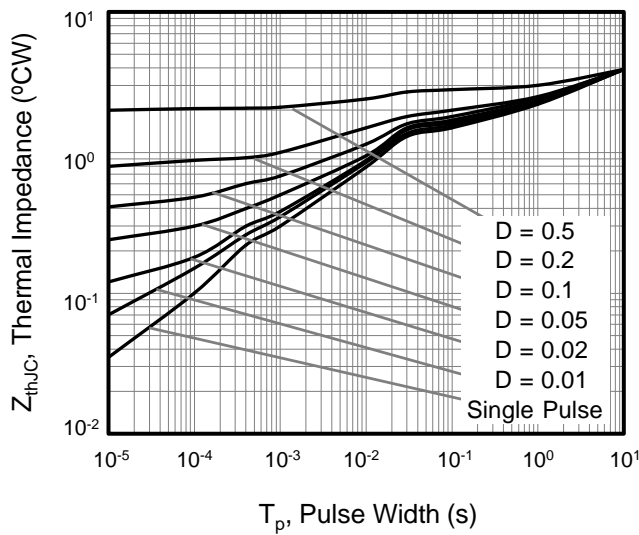

Figure 9. Transient Thermal Impedance TO-220F

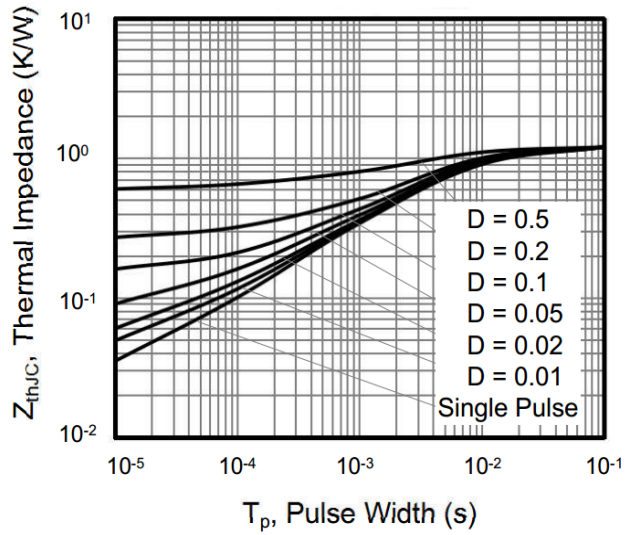
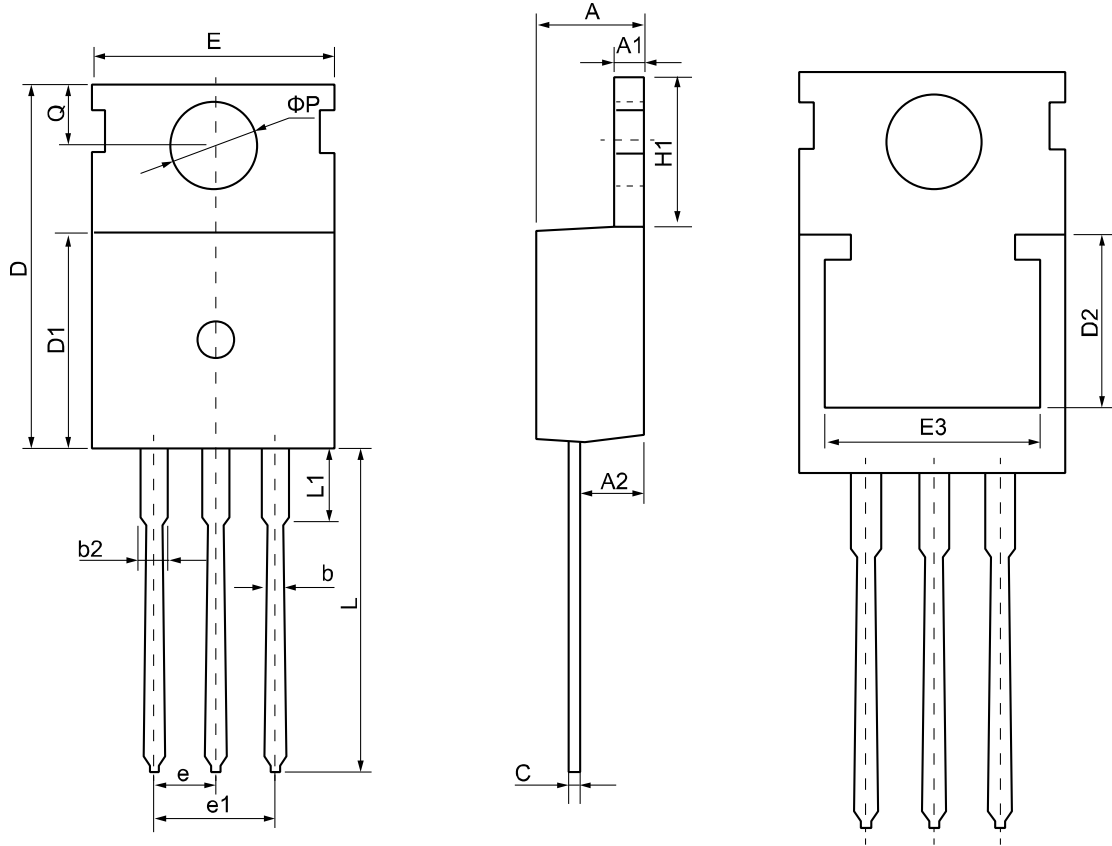

Figure 10. Transient Thermal Impedance TO-220/TO-263

TO-220 Package Outline Dimensions



Symbol	Dimensions (unit:mm)			Symbol	Dimensions (unit:mm)		
	Min	Typ	Max		Min	Typ	Max
A	4.30	4.55	4.75	E	9.65	10.00	10.25
A1	1.15	1.30	1.45	E3	7.00	--	--
A2	2.20	2.40	2.60	e	2.54 BSC		
b	0.70	0.80	0.95	e1	5.08 BSC		
b2	1.17	1.27	1.47	H1	6.30	6.50	6.80
c	0.40	0.50	0.65	L	12.70	13.50	14.10
D	15.30	15.60	15.90	L1	--	3.20	3.95
D1	8.90	9.10	9.35	ϕP	3.40	3.60	3.80
D2	5.50	--	--	Q	2.60	2.80	3.00

TO-220F Package Outline Dimensions

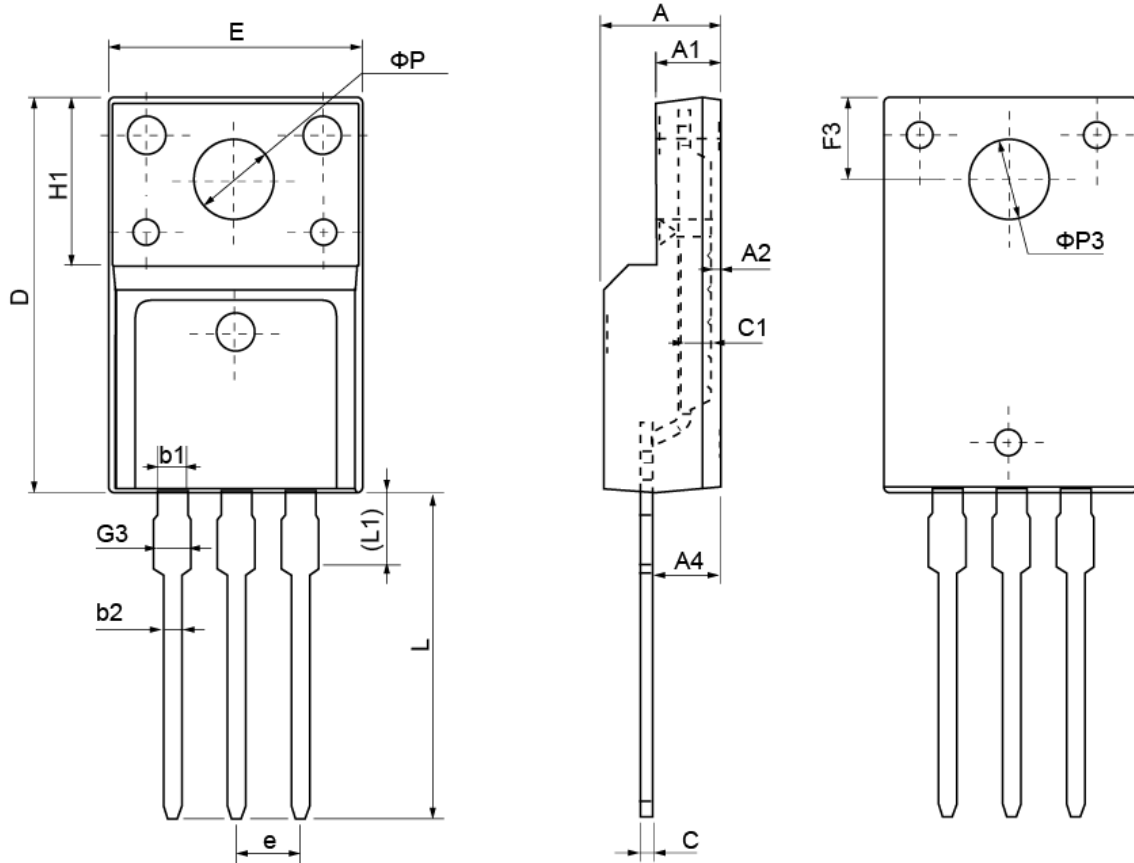

Symbol	Dimensions (unit:mm)			Symbol	Dimensions (unit:mm)		
	Min	Typ	Max		Min	Typ	Max
A	4.40	4.70	5.00	H1	6.70 REF		
A1	2.30	2.55	2.80	L	12.30	12.98	13.30
A2	0.30	0.50	0.70	L1	2.95	3.10	3.50
A4	2.45	2.80	3.05	phi P	3.03	3.20	3.50
c	0.30	0.50	0.70	phi P3	3.15	3.45	3.65
c1	1.20	1.30	1.40	b1	1.10	1.30	1.45
D	15.40	15.90	16.40	b2	0.60	0.80	1.00
E	9.86	10.16	10.46	F3	3.05	3.30	3.55
e	2.54 BSC			G3	1.15	1.35	1.55

TO-263 Package Outline Dimensions

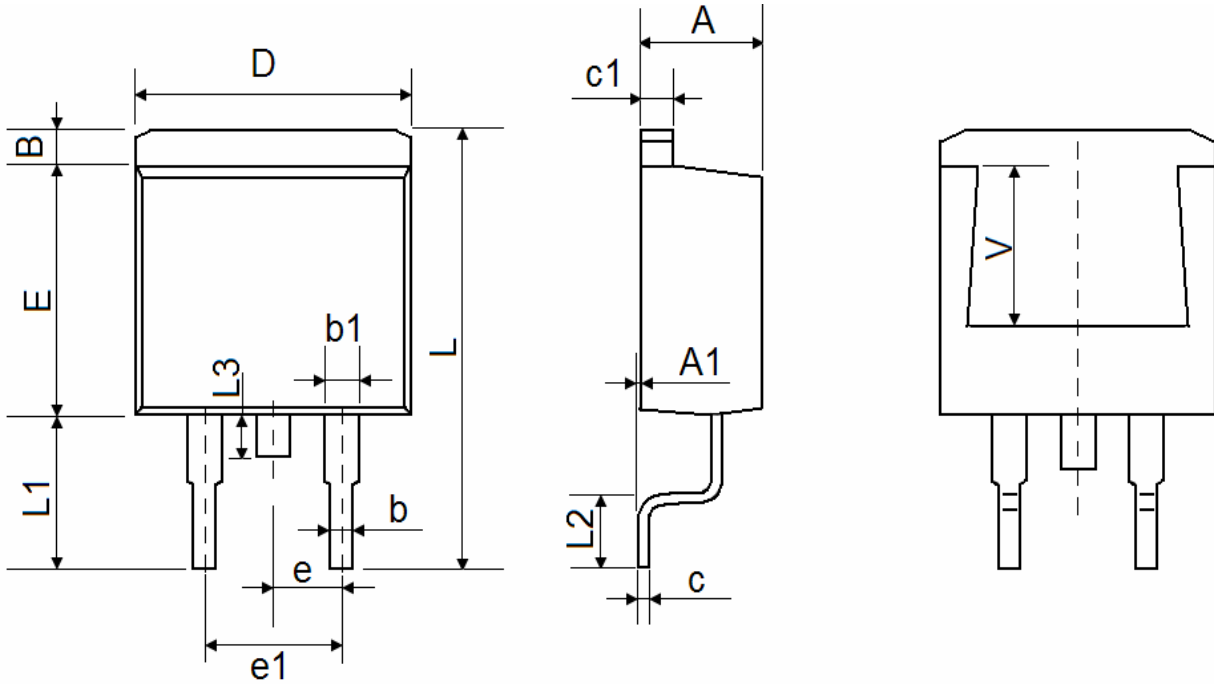

Symbol	Dimensions (unit:mm)			Symbol	Dimensions (unit:mm)		
	Min	Typ	Max		Min	Typ	Max
A	4.40	4.55	4.70	A1	0.00	0.07	0.15
B	1.00	1.20	1.40	b	0.65	0.80	0.95
b1	1.10	1.15	1.37	c	0.30	0.40	0.53
c1	1.10	1.25	1.37	D	9.80	10.00	10.40
E	8.50	8.80	9.20	e	2.54 REF		
e1	4.90	5.10	5.40	L	14.80	15.20	15.70
L1	5.00	5.25	5.60	L2	2.05	2.45	2.80
L3	1.20	1.50	1.80	V	5.60 REF		

Printing Information

ATC =====Brand

XXXXXXX =====Material Code

XXYY =====XX Representative Year
 YY Representative Weeks