

Features

- Advanced high cell density Trench technology
- Super Low Gate Charge
- Excellent CdV/dt effect decline
- 100% EAS Guaranteed
- Green Device Available

Applications

- High Frequency Point-of-Load, Synchronous Buck Converter
- Networking DC-DC Power System
- Load Switch

Product Summary



V_{DS}	100	V
I_D	86	A
$R_{DS(ON)}$ (at $V_{GS}=10V$)	6	m Ω
$R_{DS(ON)}$ (at $V_{GS}=4.5V$)	8.6	m Ω

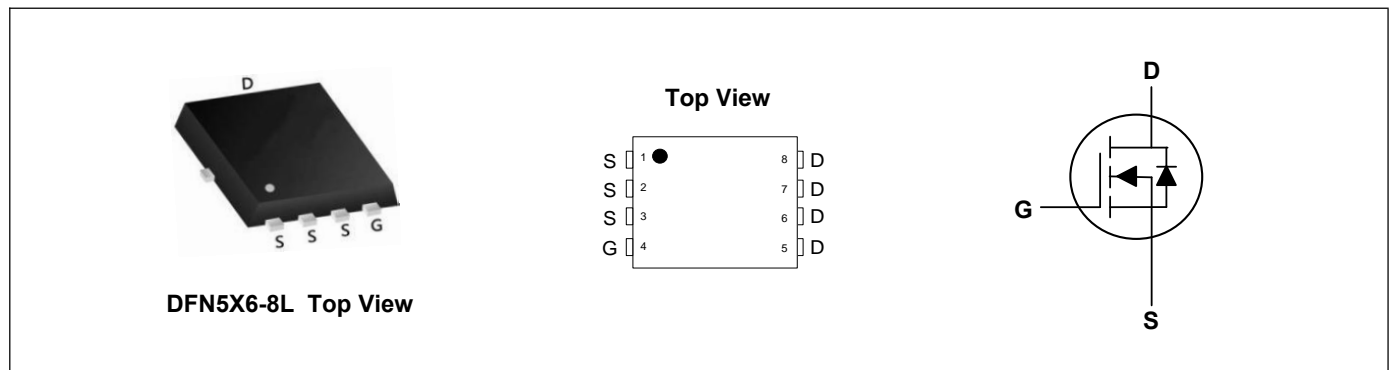

Absolute Maximum Ratings ($T_C=25^\circ\text{C}$, unless otherwise noted)

Parameter	Symbol	Rating	Units
Drain-Source Voltage	V_{DS}	100	V
Gate-Source Voltage	V_{GS}	± 20	V
Continuous Drain Current ¹	I_D	86	A
Continuous Drain Current ¹	I_D	55	A
Pulsed Drain Current ²	I_{DM}	142	A
Single Pulse Avalanche Energy ³	EAS	16	mJ
Avalanche Current	I_{AS}	18	A
Total Power Dissipation ⁴	P_D	89	W
Total Power Dissipation ⁴	P_D	36	W
Storage Temperature Range	T_{STG}	-55 to 150	$^\circ\text{C}$
Operating Junction Temperature Range	T_J	-55 to 150	$^\circ\text{C}$

Thermal Characteristics

Parameter	Symbol	Typ	Max	Unit
Thermal Resistance Junction-Ambient ¹	$R_{\theta JA}$	---	50	$^\circ\text{C/W}$
Thermal Resistance Junction-Case ¹	$R_{\theta JC}$	---	1.4	$^\circ\text{C/W}$

Electrical Characteristics (T_J=25°C, unless otherwise noted)

Parameter	Symbol	Conditions	Min	Typ	Max	Unit
Drain-Source Breakdown Voltage	BV _{DSS}	V _{GS} =0V, I _D =250uA	100	---	---	V
Static Drain-Source On-Resistance ²	R _{DS(ON)}	V _{GS} =10V, I _D =20A	---	4.6	6	mΩ
		V _{GS} =4.5V, I _D =20A	---	6.6	8.6	mΩ
Gate Threshold Voltage	V _{GS(th)}	V _{GS} =V _{DS} , I _D =250uA	1	2	3	V
Drain-Source Leakage Current	I _{DSS}	V _{DS} =80V, V _{GS} =0V, T _J =25°C	---	---	1	uA
Gate-Source Leakage Current	I _{GSS}	V _{GS} =±20V, V _{DS} =0V	---	---	±100	nA
Forward Transconductance	g _{fs}	V _{DS} =5V, I _D =20A	---	3.1	---	S
Gate Resistance	R _g	V _{DS} =0V, V _{GS} =0V, f=1MHz	---	1.7	---	Ω
Total Gate Charge	Q _g	V _{DD} =50V, V _{GS} =10V, I _D =20A	---	59	---	nC
Gate-Source Charge	Q _{gs}		---	8.1	---	
Gate-Drain Charge	Q _{gd}		---	16.4	---	
Turn-On Delay Time	T _{d(on)}	V _{DD} =50V, V _{GS} =10V, R _G =3Ω, I _D =1A	---	11	---	ns
Rise Time	T _r		---	20	---	
Turn-Off Delay Time	T _{d(off)}		---	42	---	
Fall Time	T _f		---	25	---	
Input Capacitance	C _{iss}	V _{DS} =50V, V _{GS} =0V, f=1MHz	---	3005	---	pF
Output Capacitance	C _{oss}		---	541	---	
Reverse Transfer Capacitance	C _{rss}		---	20	---	

Drain-Source Diode Characteristics

Parameter	Symbol	Conditions	Min	Typ	Max	Unit
Diode Forward Voltage ²	V _{SD}	V _{GS} =0V, I _S =20A, T _J =25°C	---	0.85	1.1	V
Reverse Recovery Time	t _{rr}	I _F =20A, di/dt=100A/μs, T _J =25°C	---	55.6	---	nS
Reverse Recovery Charge	Q _{rr}		---	109	---	nC

Note:

1. The data tested by surface mounted on a 1 inch² FR-4 board with 2OZ copper.
2. The data tested by pulsed, pulse width ≤ 300us, duty cycle ≤ 2%
3. The EAS data shows Max. rating. The test condition is V_{DD}=50V, V_{GS}=10V, L=0.5mH
4. The power dissipation is limited by 150°C junction temperature

Typical Characteristics

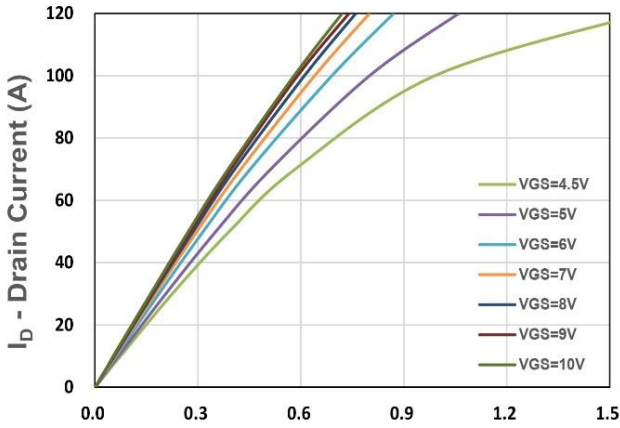

V_{DS} - Drain - Source Voltage (V)
Figure 1. Output Characteristics

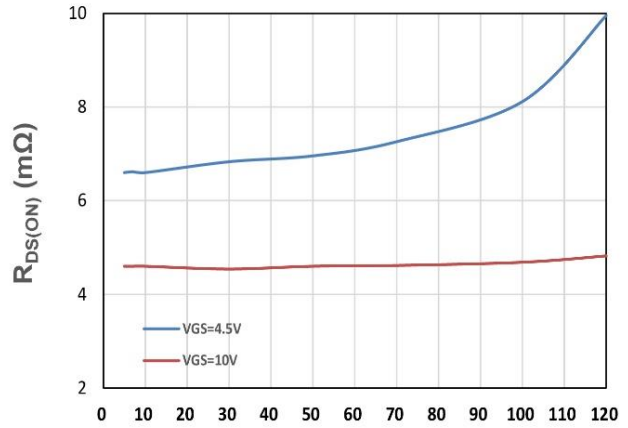

I_D - Drain Current (A)
Figure 2. On-Resistance vs. I_D

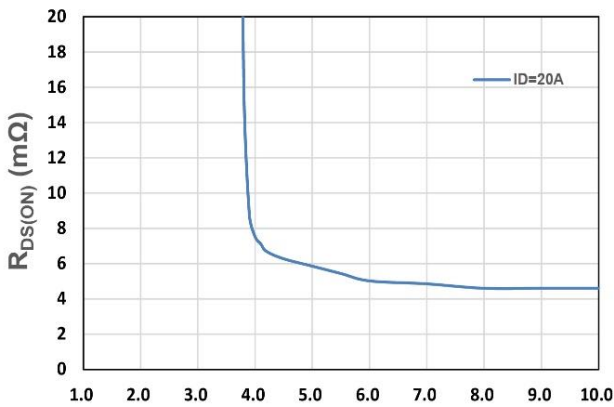

V_{GS} - Gate - Source Voltage (V)
Figure 3. On-Resistance vs. V_{GS}

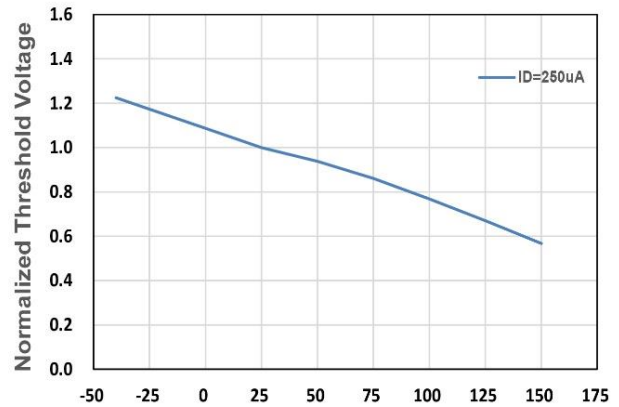

T_j , Junction Temperature($^{\circ}C$)
Figure 4. Gate Threshold Voltage

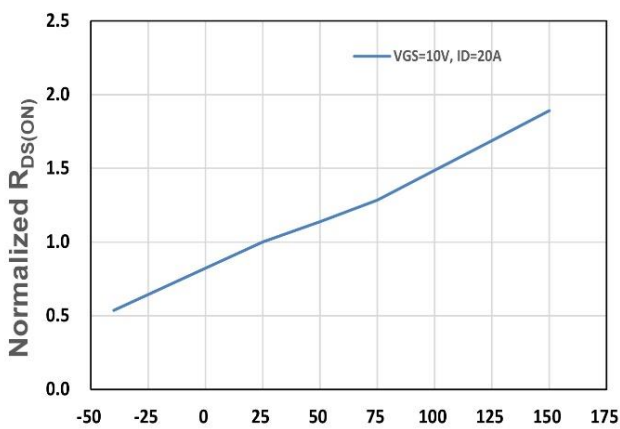

T_j , Junction Temperature($^{\circ}C$)
Figure 5. Drain-Source On Resistance

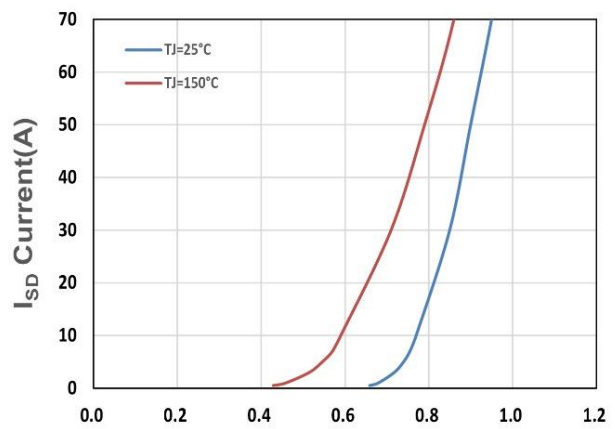

V_{SD} , Source-Drain Voltage(V)
Figure 6. Source-Drain Diode Forward

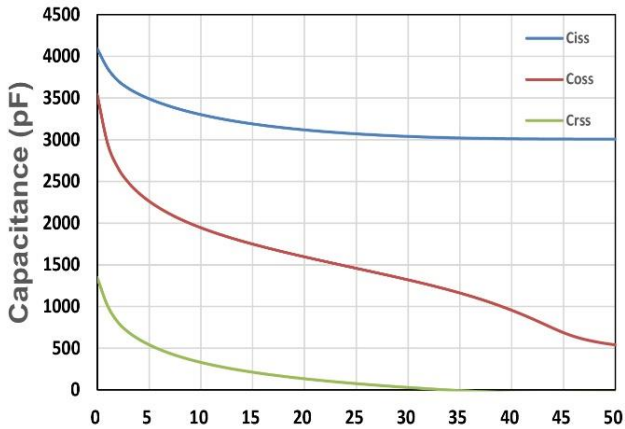

V_{DS} - Drain - Source Voltage (V)

Figure 7. Capacitance

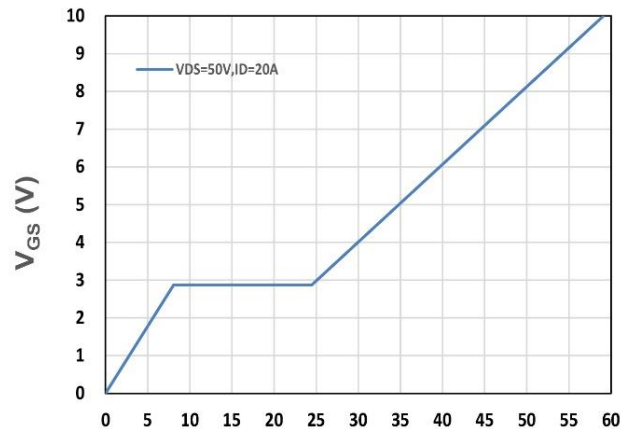

V_{GS} (V)

Figure 8. Gate Charge Characteristics

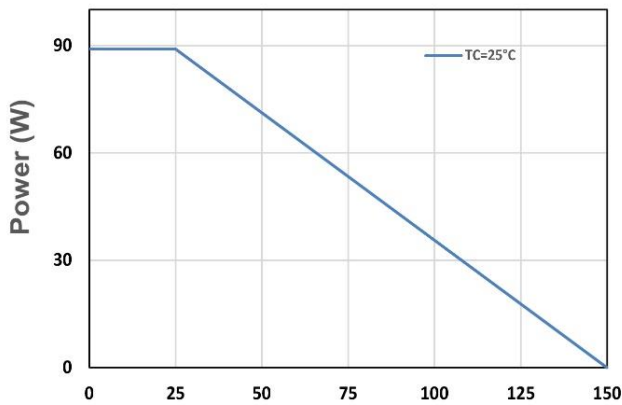

T_j - Junction Temperature ($^{\circ}C$)

Figure 9. Power Dissipation

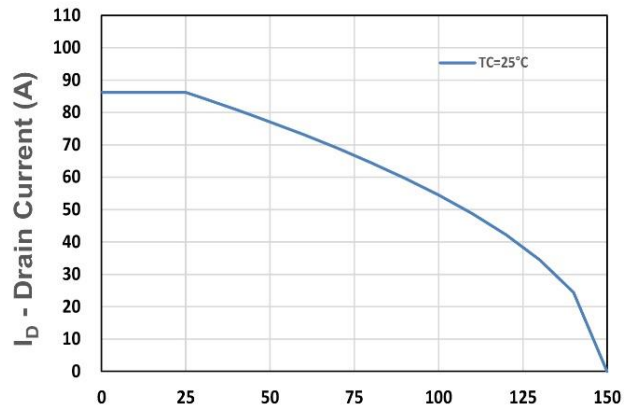

T_j - Junction Temperature ($^{\circ}C$)

Figure 10. Drain Current

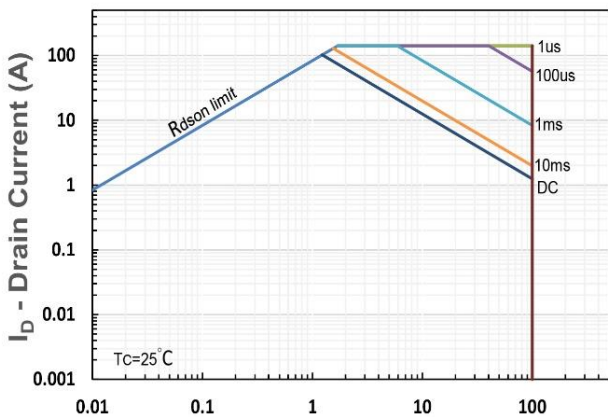

V_{DS} - Drain-Source Voltage (V)

Figure 11. Safe Operating Area

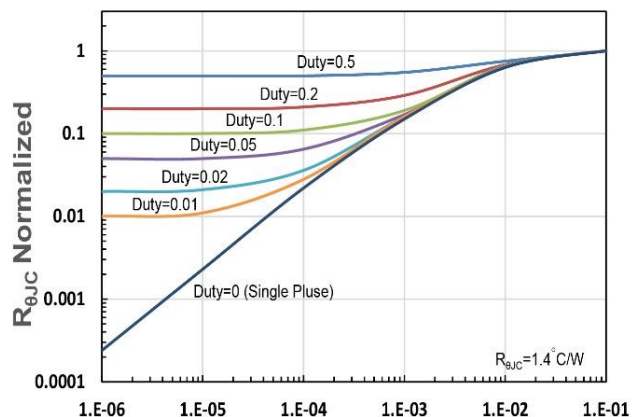

t_1 , Square Wave Pulse Duration (s)

Figure 12. $R_{\theta JC}$ Transient Thermal Impedance

DFN5X6-8L Package Outline Dimensions

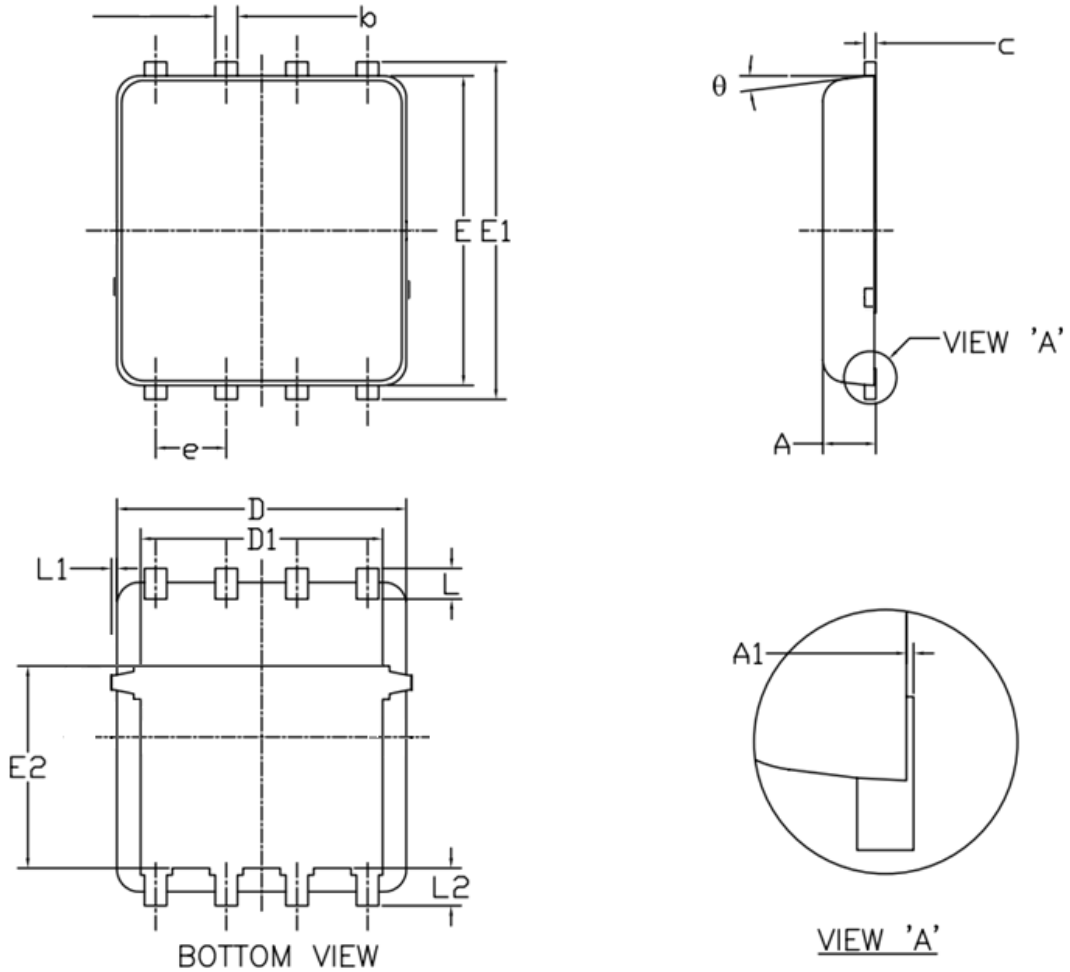

Symbol	Dimensions (unit:mm)			Symbol	Dimensions (unit:mm)		
	Min	Typ	Max		Min	Typ	Max
A	0.90	1.00	1.20	E1	5.90	6.10	6.35
A1	0.00	--	0.05	E2	3.38	3.58	3.92
b	0.30	0.40	0.51	e	1.27 BSC		
c	0.20	0.25	0.33	L	0.51	0.61	0.71
D	4.80	4.90	5.40	L1	--	--	0.15
D1	3.61	4.00	4.25	L2	0.41	0.51	0.61
E	5.65	5.80	6.06	θ	0°	--	12°

Printing Information

ATC =====Brand

XXXXXXXX =====Material Code

XXYY =====XX Representative Year
 YY Representative Weeks