

**Features**

- Advanced Shield Gate Trench technology
- Super Low Gate Charge
- High-Speed Switching
- 100% EAS Guaranteed
- Green Device Available

**Product Summary**



$V_{DS}$	40	V
$I_D$	150	A
$R_{DS(ON)}$ (at $V_{GS}=10V$ )	1.5	m $\Omega$
$R_{DS(ON)}$ (at $V_{GS}=4.5V$ )	2.4	m $\Omega$

**Applications**

- High Frequency Point-of-Load, Synchronous Buck Converter
- Networking DC-DC Power System
- Load Switch

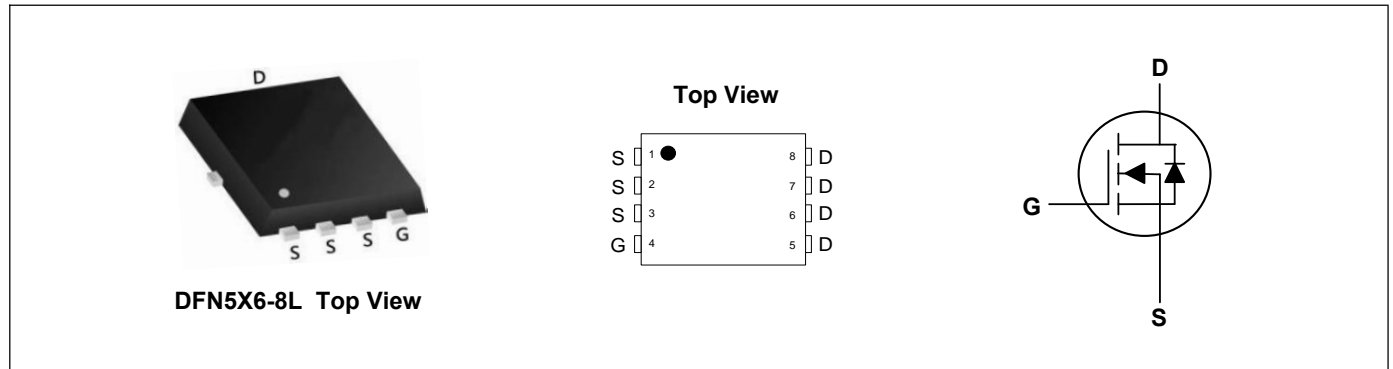

**Absolute Maximum Ratings( $T_C=25^\circ C$ , unless otherwise noted)**

Parameter	Symbol	Rating	Units
Drain-Source Voltage	$V_{DS}$	40	V
Gate-Source Voltage	$V_{GS}$	$\pm 20$	V
Continuous Drain Current <sup>1</sup>	$I_D$	150	A
Pulsed Drain Current <sup>2</sup>	$I_{DM}$	320	A
Single Pulse Avalanche Energy <sup>3</sup>	$E_{AS}$	1200	mJ
Total Power Dissipation	$P_D$	35	W
Storage Temperature Range	$T_{STG}$	-55 to 175	$^\circ C$
Operating Junction Temperature Range	$T_J$	-55 to 175	$^\circ C$

**Thermal Characteristics**

Parameter	Symbol	Typ	Max	Unit
Thermal Resistance Junction-Ambient <sup>1</sup>	$R_{\theta JA}$	---	62.5	$^\circ C/W$
Thermal Resistance Junction-Case <sup>1</sup>	$R_{\theta JC}$	---	3.5	$^\circ C/W$

**Electrical Characteristics (T<sub>J</sub>=25°C, unless otherwise noted)**

Parameter	Symbol	Conditions	Min	Typ	Max	Unit
Drain-Source Breakdown Voltage	BV <sub>DSS</sub>	V <sub>GS</sub> =0V, I <sub>D</sub> =250uA	40	---	---	V
Static Drain-Source On-Resistance	R <sub>DS(ON)</sub>	V <sub>GS</sub> =10V, I <sub>D</sub> =20A	---	1.2	1.5	mΩ
		V <sub>GS</sub> =4.5V, I <sub>D</sub> =10A	---	1.9	2.4	mΩ
Gate Threshold Voltage	V <sub>GS(th)</sub>	V <sub>GS</sub> =V <sub>DS</sub> , I <sub>D</sub> =250uA	1.0	---	2.5	V
Drain-Source Leakage Current	I <sub>DSS</sub>	V <sub>DS</sub> =32V, V <sub>GS</sub> =0V	---	---	1	uA
Gate-Source Leakage Current	I <sub>GSS</sub>	V <sub>GS</sub> =±20V, V <sub>DS</sub> =0V	---	---	±100	nA
Total Gate Charge	Q <sub>g</sub>	V <sub>DS</sub> =20V, V <sub>GS</sub> =10V, I <sub>D</sub> =20A	---	80	---	nC
Gate-Source Charge	Q <sub>gs</sub>		---	18	---	
Gate-Drain Charge	Q <sub>gd</sub>		---	15	---	
Turn-On Delay Time	T <sub>d(on)</sub>	V <sub>DS</sub> =20V, V <sub>GS</sub> =10V, R <sub>G</sub> =4.5Ω, R <sub>L</sub> =1Ω, I <sub>D</sub> =20A	---	15	---	ns
Rise Time	T <sub>r</sub>		---	46	---	
Turn-Off Delay Time	T <sub>d(off)</sub>		---	75	---	
Fall Time	T <sub>f</sub>		---	40	---	
Input Capacitance	C <sub>iss</sub>	V <sub>DS</sub> =20V, V <sub>GS</sub> =0V, f=1MHz	---	4950	---	pF
Output Capacitance	C <sub>oss</sub>		---	1610	---	
Reverse Transfer Capacitance	C <sub>rss</sub>		---	115	---	

**Drain-Source Diode Characteristics**

Parameter	Symbol	Conditions	Min	Typ	Max	Unit
Continuous Source Current <sup>1</sup>	I <sub>S</sub>		---	---	150	A
Diode Forward Voltage <sup>2</sup>	V <sub>SD</sub>	V <sub>GS</sub> =0V, I <sub>S</sub> =20A, T <sub>J</sub> =25°C	---	---	1.3	V
Reverse Recovery Time	t <sub>rr</sub>	I <sub>F</sub> =20A	---	65	---	nS
Reverse Recovery Charge	Q <sub>rr</sub>	di/dt=100A/μs, T <sub>J</sub> =25°C	---	90	---	nC

**Note:**

- 1.The data tested by surface mounted on a 1 inch<sup>2</sup> FR-4 board with 2OZ copper.
- 2.The data tested by pulsed, pulse width ≤ 300us, duty cycle ≤ 2%
- 3.The EAS data shows Max. rating. The test condition is V<sub>DD</sub>=40V, L=0.5mH

**Typical Characteristics**

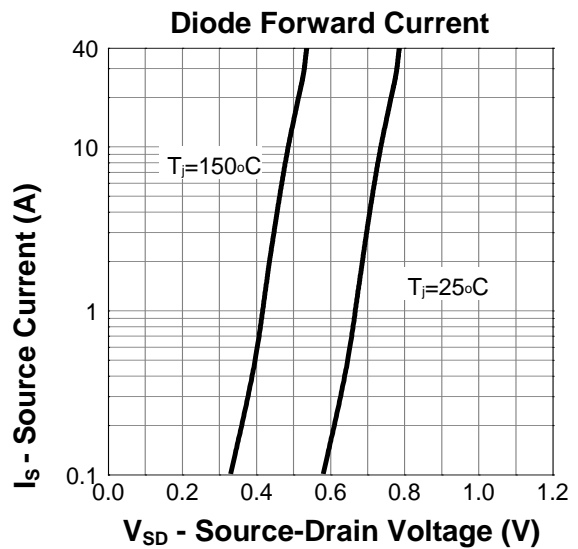
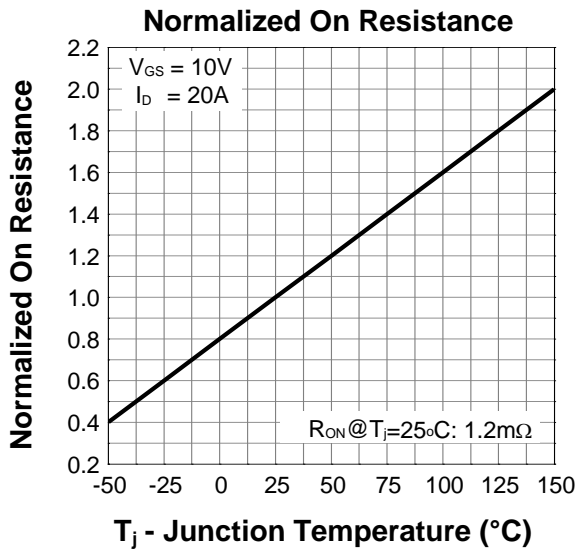
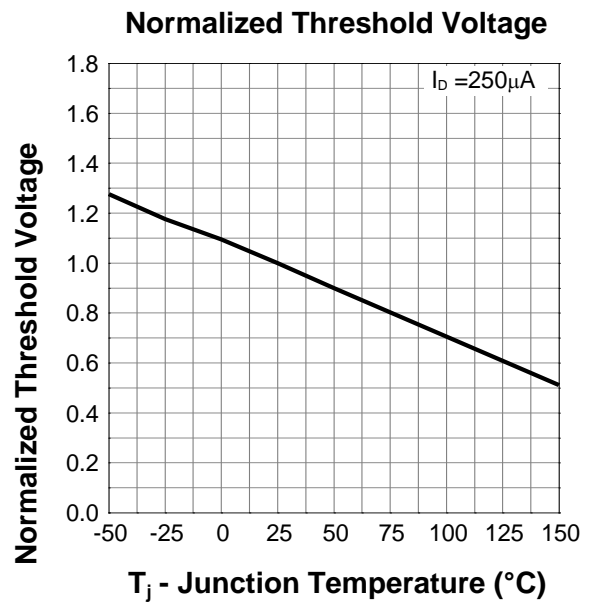
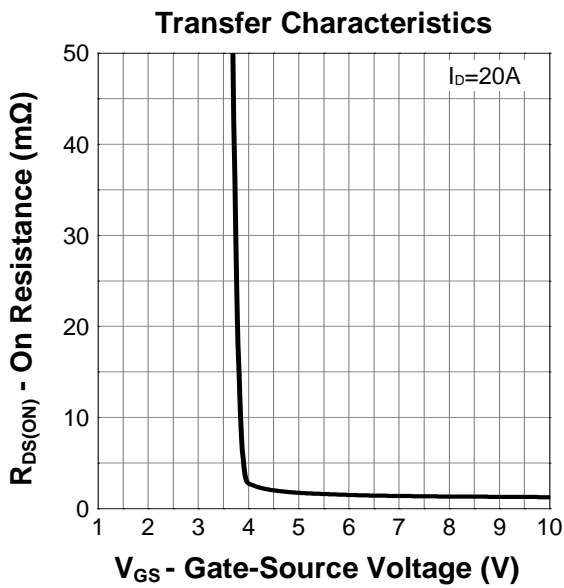
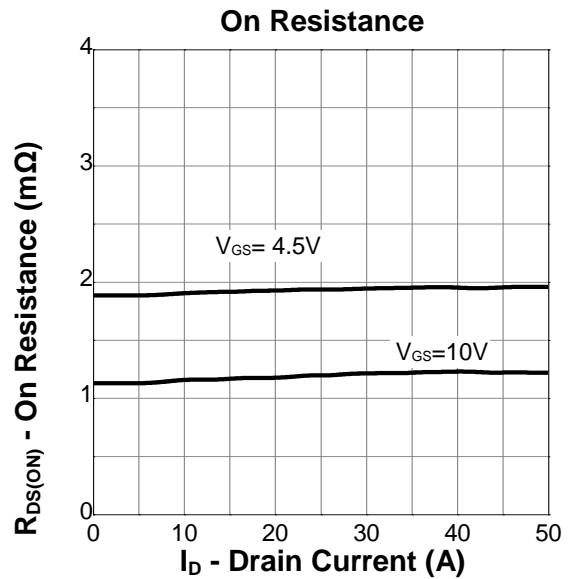
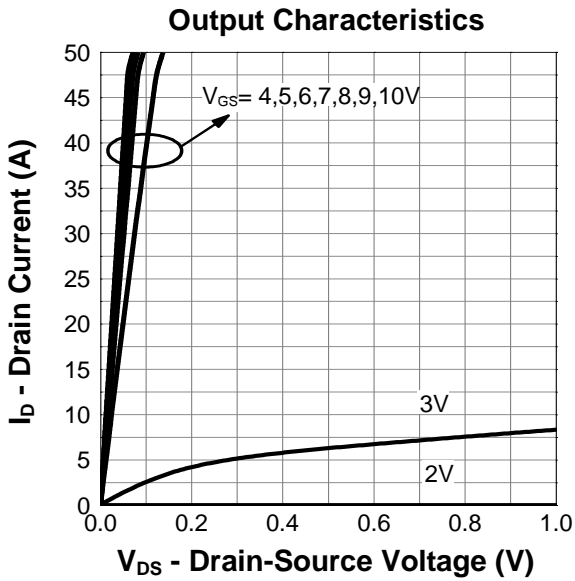

**Capacitance**

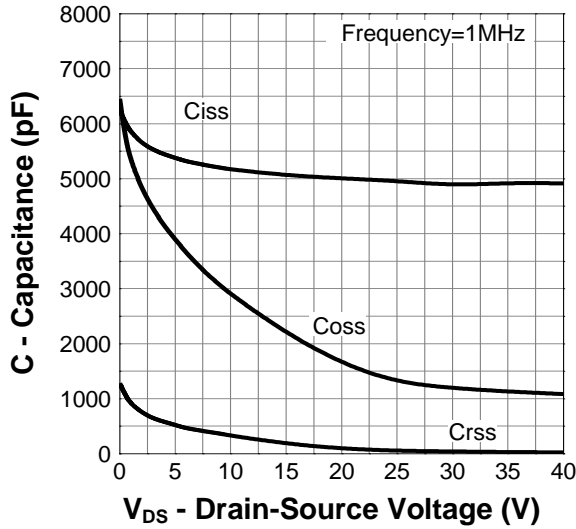

**Gate Charge**

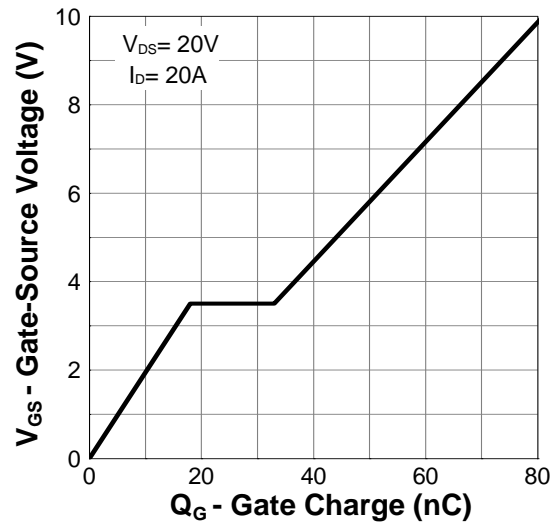

**Power Capability**

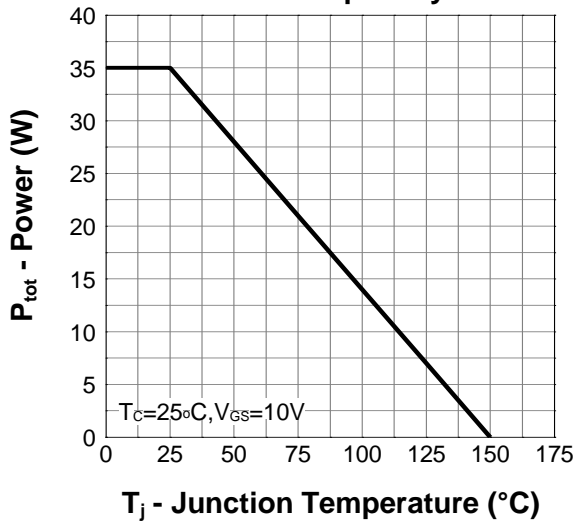

**Current Capability**

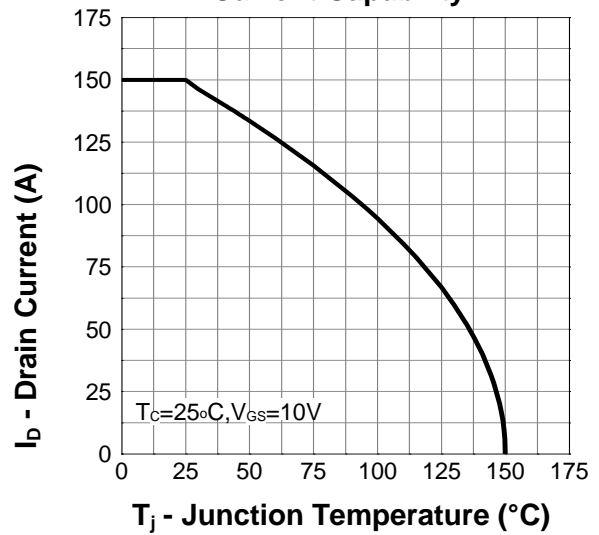

**Safe Operation Area**

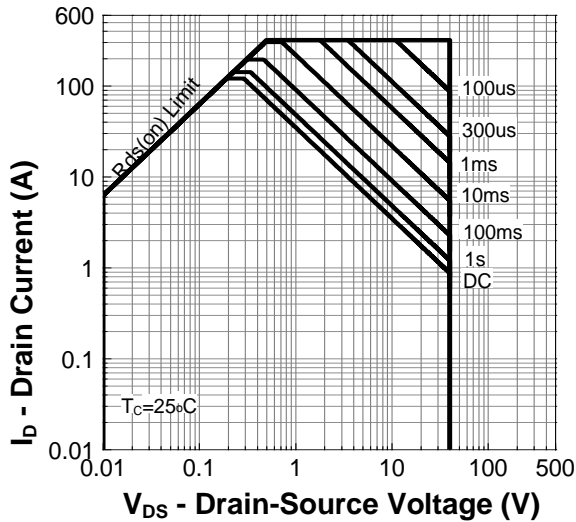

**Transient Thermal Impedance**

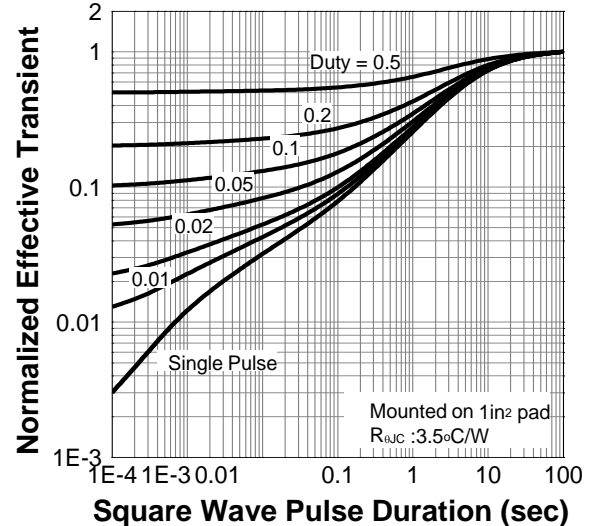

**DFN5X6-8L Package Outline Dimensions**

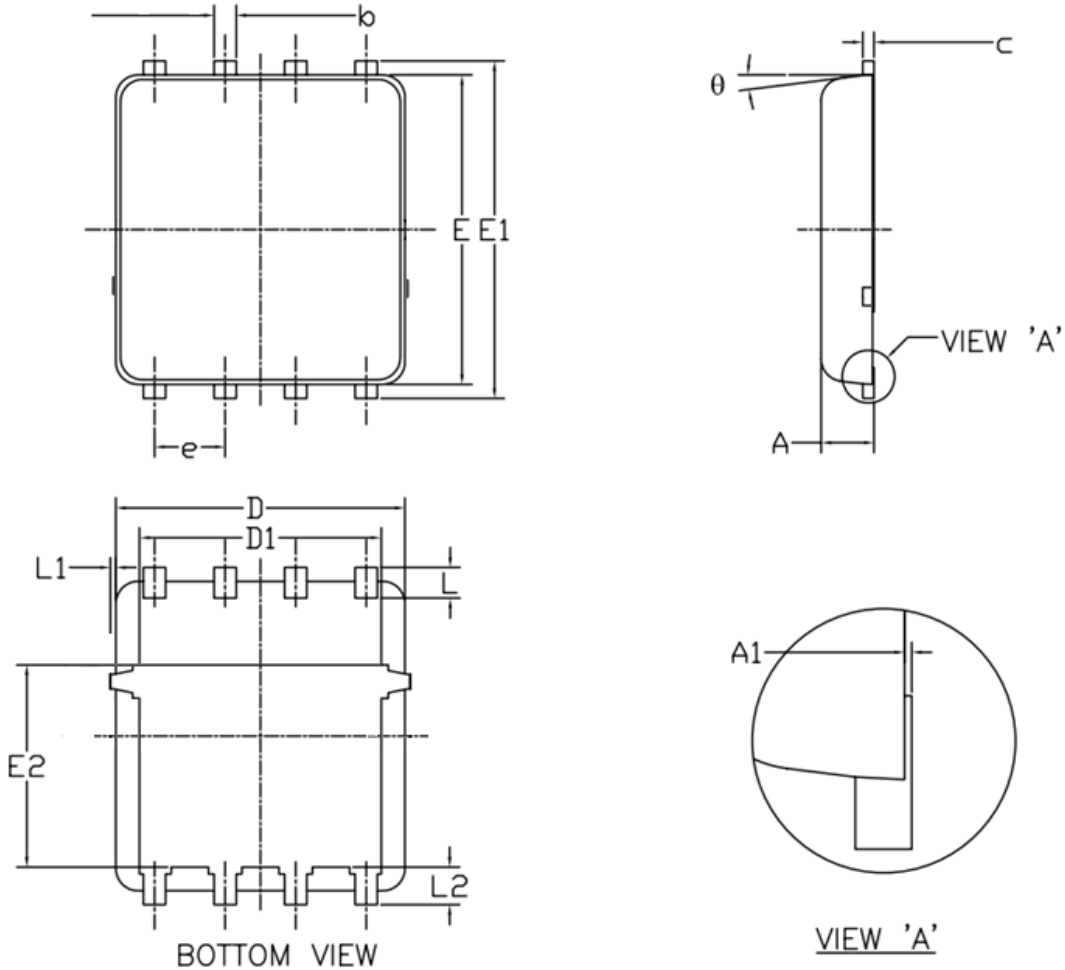

Symbol	Dimensions (unit:mm)			Symbol	Dimensions (unit:mm)		
	Min	Typ	Max		Min	Typ	Max
<b>A</b>	0.90	1.00	1.20	<b>E1</b>	5.90	6.10	6.35
<b>A1</b>	0.00	--	0.05	<b>E2</b>	3.38	3.58	3.92
<b>b</b>	0.30	0.40	0.51	<b>e</b>	1.27 BSC		
<b>c</b>	0.20	0.25	0.33	<b>L</b>	0.51	0.61	0.71
<b>D</b>	4.80	4.90	5.40	<b>L1</b>	--	--	0.15
<b>D1</b>	3.61	4.00	4.25	<b>L2</b>	0.41	0.51	0.61
<b>E</b>	5.65	5.80	6.06	<b>theta</b>	0°	--	12°

**Printing Information**

ATC           =====Brand

XXXXXXXX     =====Material Code

XXYY           =====XX Representative Year  
                  YY Representative Weeks