

Features

- Advanced Shield Gate Trench technology
- Super Low Gate Charge
- High-Speed Switching
- 100% EAS Guaranteed
- Green Device Available

Product Summary



V_{DS}	40	V
I_D	155	A
$R_{DS(ON)}$ (at $V_{GS}=10V$)	1.4	m Ω

Applications

- High Frequency Point-of-Load, Synchronous Buck Converter
- Networking DC-DC Power System
- Load Switch

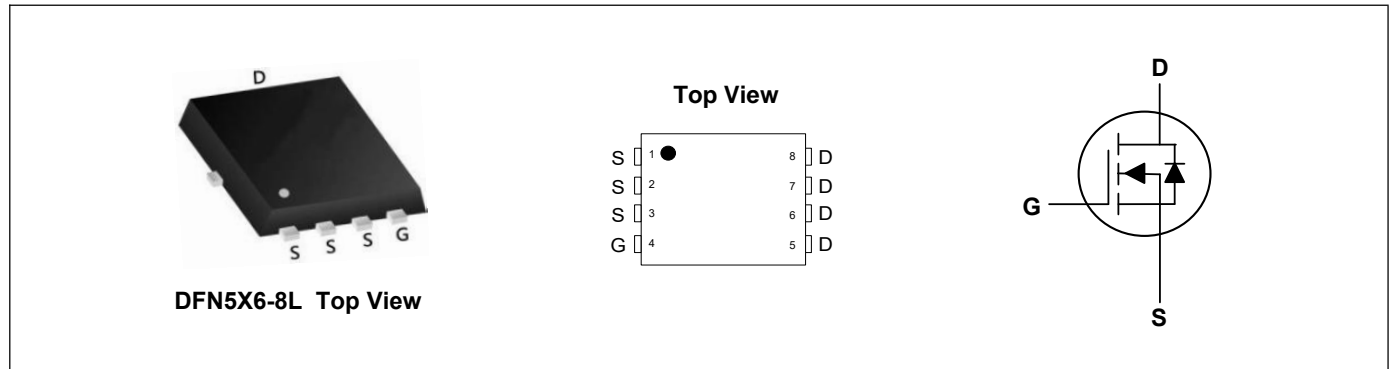

Absolute Maximum Ratings($T_C=25^\circ C$, unless otherwise noted)

Parameter	Symbol	Rating	Units
Drain-Source Voltage	V_{DS}	40	V
Gate-Source Voltage	V_{GS}	± 20	V
Continuous Drain Current ¹	I_D	155	A
Pulsed Drain Current ²	I_{DM}	650	A
Single Pulse Avalanche Energy ³	E_{AS}	800	mJ
Total Power Dissipation	P_D	42	W
Storage Temperature Range	T_{STG}	-55 to 175	$^\circ C$
Operating Junction Temperature Range	T_J	-55 to 175	$^\circ C$

Thermal Characteristics

Parameter	Symbol	Typ	Max	Unit
Thermal Resistance Junction-Ambient ¹	$R_{\theta JA}$	---	62.5	$^\circ C/W$
Thermal Resistance Junction-Case ¹	$R_{\theta JC}$	---	3.5	$^\circ C/W$

Electrical Characteristics ($T_J=25^{\circ}\text{C}$, unless otherwise noted)

Parameter	Symbol	Conditions	Min	Typ	Max	Unit
Drain-Source Breakdown Voltage	BV_{DSS}	$V_{GS}=0V, I_D=250\mu A$	40	---	---	V
Static Drain-Source On-Resistance	$R_{DS(ON)}$	$V_{GS}=10V, I_D=30A$	---	1.1	1.4	$m\Omega$
Gate Threshold Voltage	$V_{GS(th)}$	$V_{GS}=V_{DS}, I_D=250\mu A$	2.0	---	4.0	V
Drain-Source Leakage Current	I_{DSS}	$V_{DS}=32V, V_{GS}=0V$	---	---	1	μA
Gate-Source Leakage Current	I_{GSS}	$V_{GS}=\pm 20V, V_{DS}=0V$	---	---	± 100	nA
Total Gate Charge	Q_g	$V_{DS}=20V, V_{GS}=10V, I_D=30A$	---	80	---	nC
Gate-Source Charge	Q_{gs}		---	26	---	
Gate-Drain Charge	Q_{gd}		---	20	---	
Turn-On Delay Time	$T_{d(on)}$	$V_{DD}=20V, V_{GS}=10V, R_G=3.9\Omega, R_L=0.66\Omega, I_D=30A$	---	18	---	ns
Rise Time	T_r		---	78	---	
Turn-Off Delay Time	$T_{d(off)}$		---	50	---	
Fall Time	T_f		---	45	---	
Input Capacitance	C_{iss}	$V_{DS}=20V, V_{GS}=0V, f=1\text{MHz}$	---	4910	---	pF
Output Capacitance	C_{oss}		---	2000	---	
Reverse Transfer Capacitance	C_{rss}		---	165	---	

Drain-Source Diode Characteristics

Parameter	Symbol	Conditions	Min	Typ	Max	Unit
Continuous Source Current ¹	I_S		---	---	165	A
Diode Forward Voltage ²	V_{SD}	$V_{GS}=0V, I_S=30A, T_J=25^{\circ}\text{C}$	---	---	1.3	V
Reverse Recovery Time	t_{rr}	$I_F=30A$ $di/dt=100A/\mu s, T_J=25^{\circ}\text{C}$	---	62	---	nS
Reverse Recovery Charge	Q_{rr}		---	65	---	nC

Note:

- 1.The data tested by surface mounted on a 1 inch² FR-4 board with 2OZ copper.
- 2.The data tested by pulsed , pulse width $\leq 300\mu s$, duty cycle $\leq 2\%$
- 3.The EAS data shows Max. rating . The test condition is $V_{DD}=20V, L=0.5mH$

Typical Characteristics

Output Characteristics

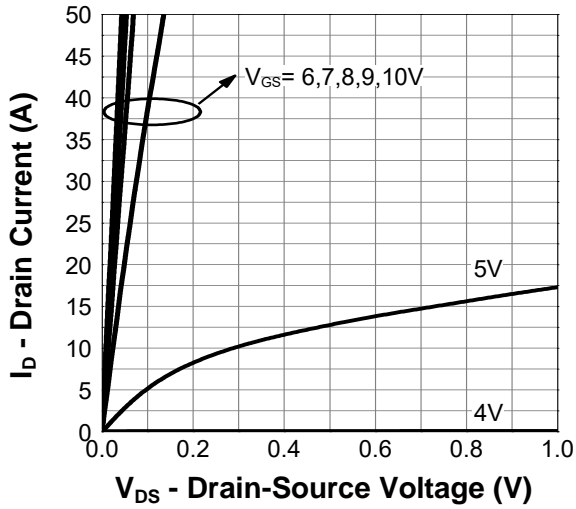

On Resistance

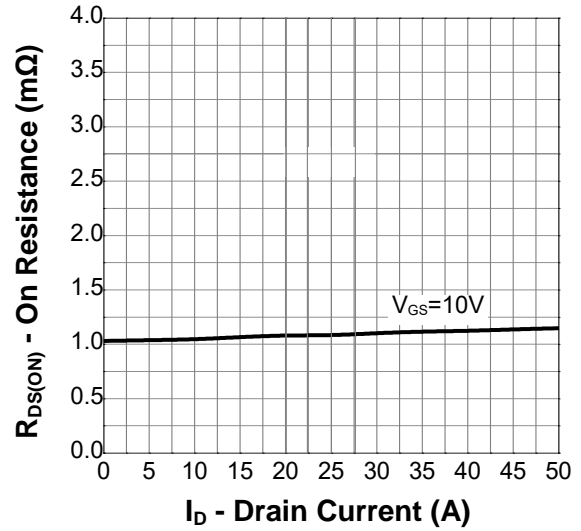

Transfer Characteristics

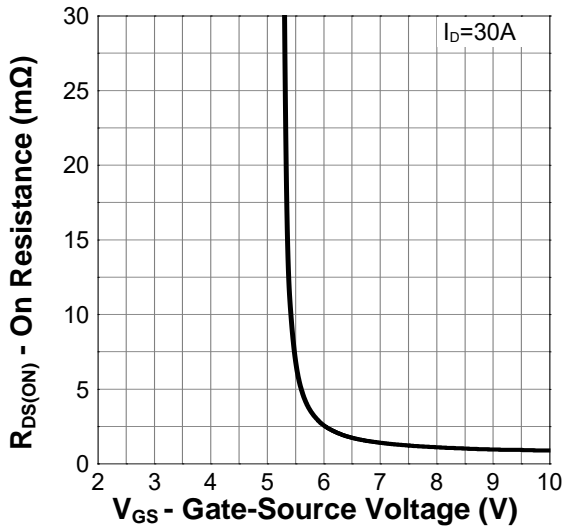

Normalized On Resistance

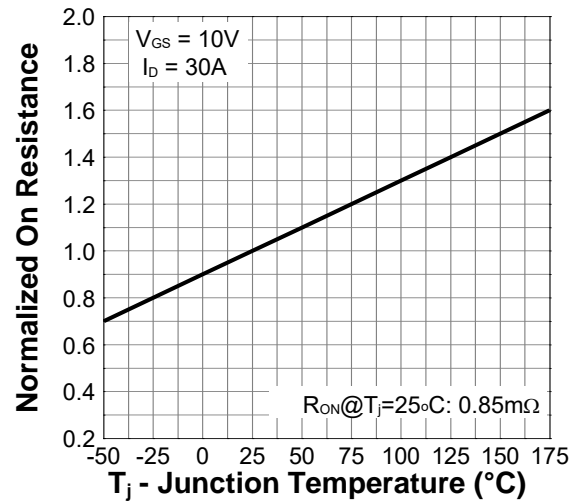

Capacitance

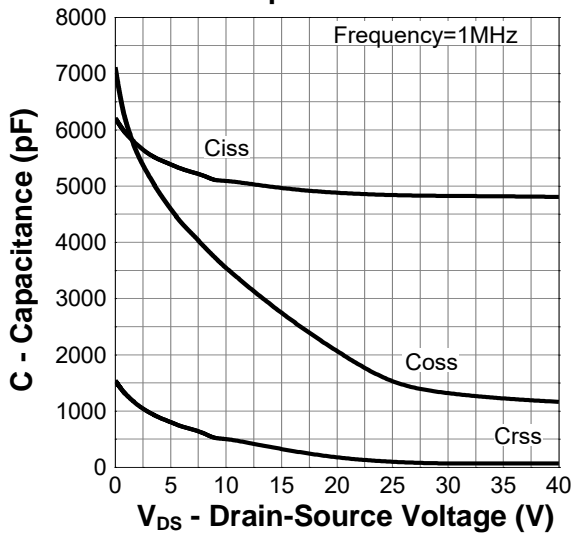

Gate Charge

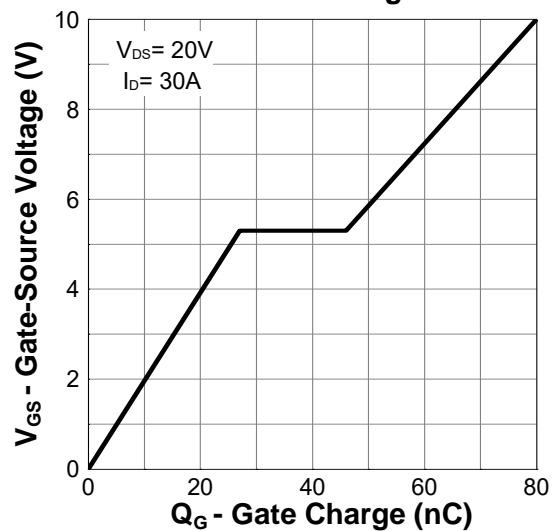

Power Capability

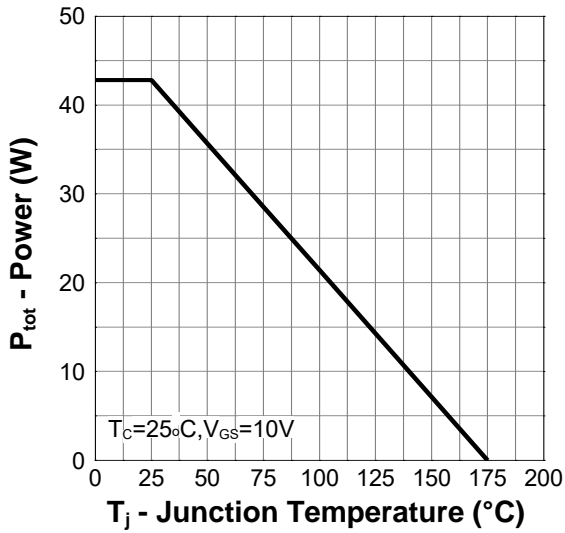

Current Capability

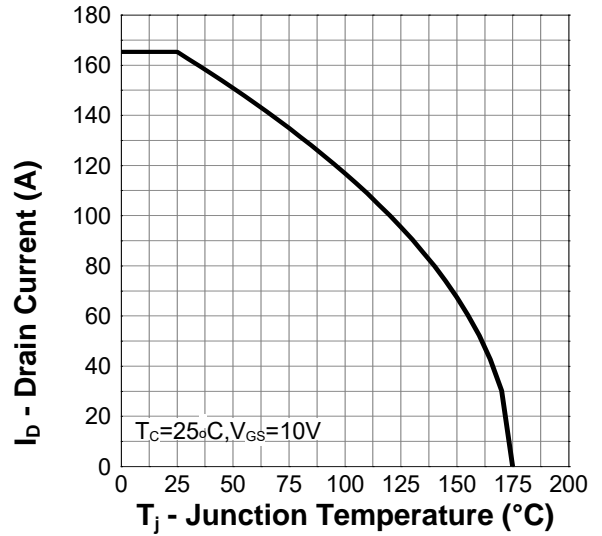

Safe Operation Area

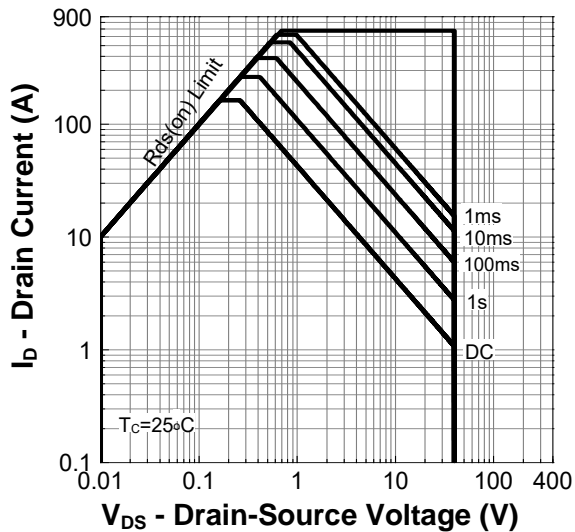

Transient Thermal Impedance

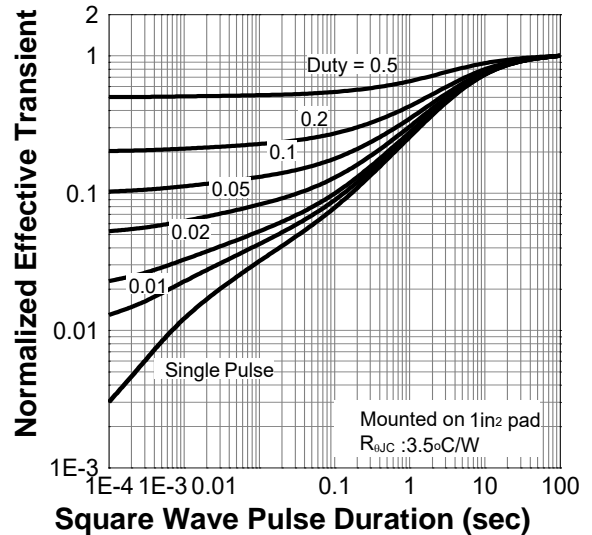

DFN5X6-8L Package Outline Dimensions

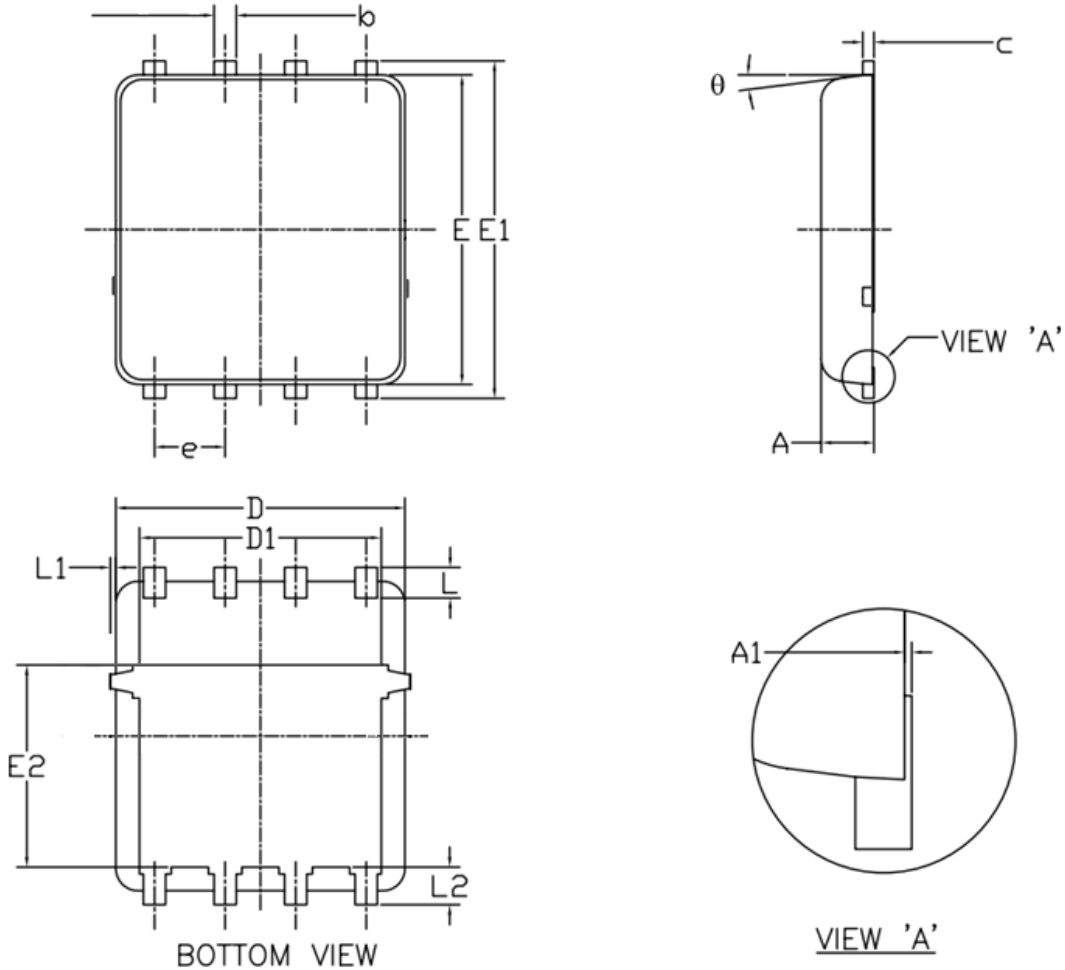

Symbol	Dimensions (unit:mm)			Symbol	Dimensions (unit:mm)		
	Min	Typ	Max		Min	Typ	Max
A	0.90	1.00	1.20	E1	5.90	6.10	6.35
A1	0.00	--	0.05	E2	3.38	3.58	3.92
b	0.30	0.40	0.51	e	1.27 BSC		
c	0.20	0.25	0.33	L	0.51	0.61	0.71
D	4.80	4.90	5.40	L1	--	--	0.15
D1	3.61	4.00	4.25	L2	0.41	0.51	0.61
E	5.65	5.80	6.06	θ	0°	--	12°