

Features

- Advanced Shield Gate Trench technology
- Super Low Gate Charge
- High-Speed Switching
- 100% EAS Guaranteed
- Green Device Available

Product Summary



V_{DS}	30	V
I_D	200	A
$R_{DS(ON)}$ (at $V_{GS}=10V$)	0.85	m Ω
$R_{DS(ON)}$ (at $V_{GS}=4.5V$)	1.45	m Ω

Applications

- High Frequency Point-of-Load, Synchronous Buck Converter
- Networking DC-DC Power System
- Load Switch

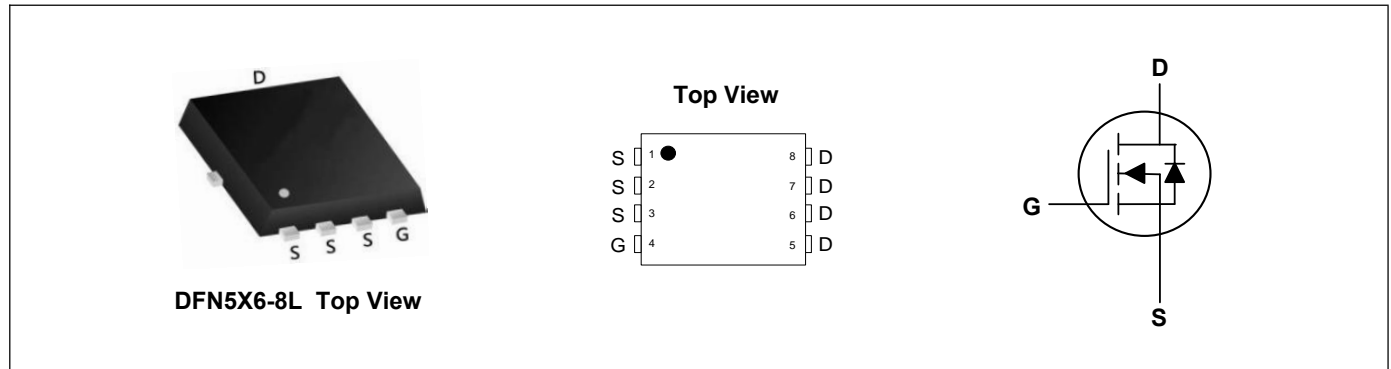

Absolute Maximum Ratings ($T_C=25^\circ C$, unless otherwise noted)

Parameter	Symbol	Rating	Units
Drain-Source Voltage	V_{DS}	30	V
Gate-Source Voltage	V_{GS}	± 20	V
Continuous Drain Current ¹	I_D	200	A
Pulsed Drain Current ²	I_{DM}	644	A
Single Pulse Avalanche Energy ³	E_{AS}	1058	mJ
Total Power Dissipation	P_D	35	W
Storage Temperature Range	T_{STG}	-55 to 175	$^\circ C$
Operating Junction Temperature Range	T_J	-55 to 175	$^\circ C$

Thermal Characteristics

Parameter	Symbol	Typ	Max	Unit
Thermal Resistance Junction-Ambient ¹	$R_{\theta JA}$	---	62.5	$^\circ C/W$
Thermal Resistance Junction-Case ¹	$R_{\theta JC}$	---	3.5	$^\circ C/W$

Electrical Characteristics (T_J=25°C, unless otherwise noted)

Parameter	Symbol	Conditions	Min	Typ	Max	Unit
Drain-Source Breakdown Voltage	BV _{DSS}	V _{GS} =0V, I _D =250uA	30	---	---	V
Static Drain-Source On-Resistance	R _{DS(ON)}	V _{GS} =10V, I _D =50A	---	0.75	0.85	mΩ
		V _{GS} =4.5V, I _D =30A	---	1.25	1.45	mΩ
Gate Threshold Voltage	V _{GS(th)}	V _{GS} =V _{DS} , I _D =250uA	1.0	---	2.0	V
Drain-Source Leakage Current	I _{DSS}	V _{DS} =24V, V _{GS} =0V	---	---	1	uA
Gate-Source Leakage Current	I _{GSS}	V _{GS} =±20V, V _{DS} =0V	---	---	±100	nA
Total Gate Charge	Q _g	V _{DS} =15V, V _{GS} =10V, I _D =50A	---	190	---	nC
Gate-Source Charge	Q _{gs}		---	40	---	
Gate-Drain Charge	Q _{gd}		---	33	---	
Turn-On Delay Time	T _{d(on)}	V _{DS} =15V, V _{GS} =10V, R _G =4.5Ω, R _L =0.3Ω, I _D =50A	---	25	---	ns
Rise Time	T _r		---	94	---	
Turn-Off Delay Time	T _{d(off)}		---	148	---	
Fall Time	T _f		---	98	---	
Input Capacitance	C _{iss}	V _{DS} =15V, V _{GS} =0V, f=1MHz	---	9950	---	pF
Output Capacitance	C _{oss}		---	1260	---	
Reverse Transfer Capacitance	C _{rss}		---	475	---	

Drain-Source Diode Characteristics

Parameter	Symbol	Conditions	Min	Typ	Max	Unit
Continuous Source Current ¹	I _S		---	---	200	A
Diode Forward Voltage ²	V _{SD}	V _{GS} =0V, I _S =50A, T _J =25°C	---	---	1.3	V
Reverse Recovery Time	t _{rr}	I _F =40A	---	35	---	nS
Reverse Recovery Charge	Q _{rr}	di/dt=100A/μs, T _J =25°C	---	23	---	nC

Note:

- 1.The data tested by surface mounted on a 1 inch² FR-4 board with 2OZ copper.
- 2.The data tested by pulsed, pulse width ≤ 300us, duty cycle ≤ 2%
- 3.The EAS data shows Max. rating. The test condition is V_{DD}=30V, L=1mH

Typical Characteristics

Output Characteristics

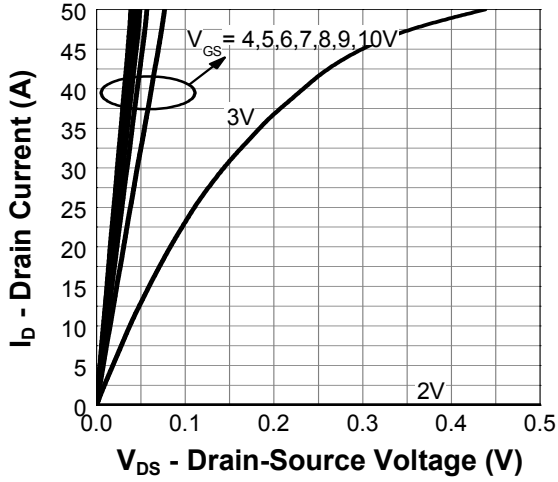

Normalized Threshold Voltage

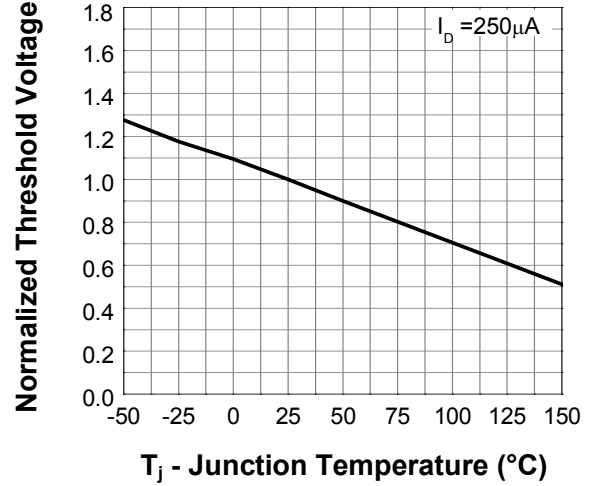

On Resistance

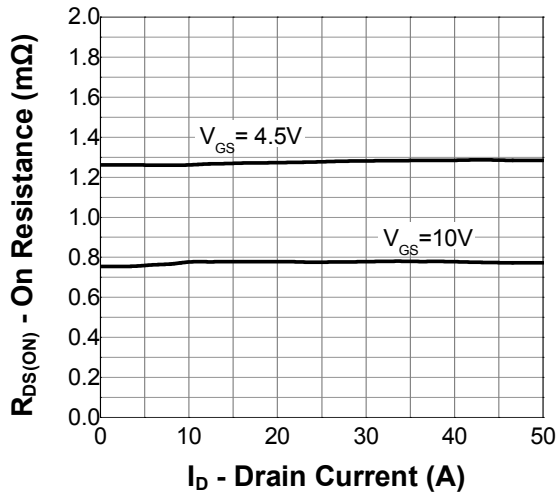

Capacitance

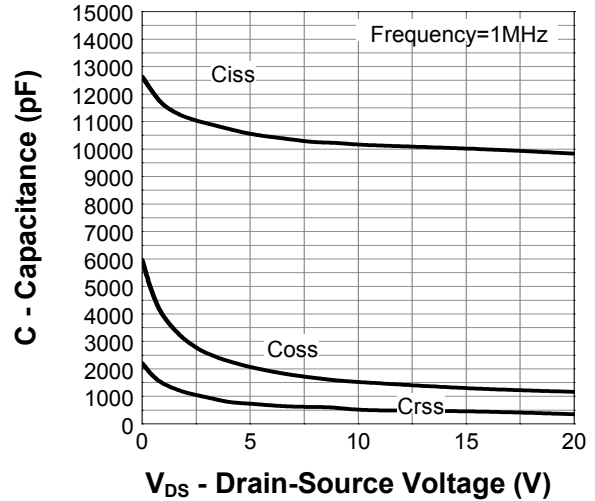

Transfer Characteristics

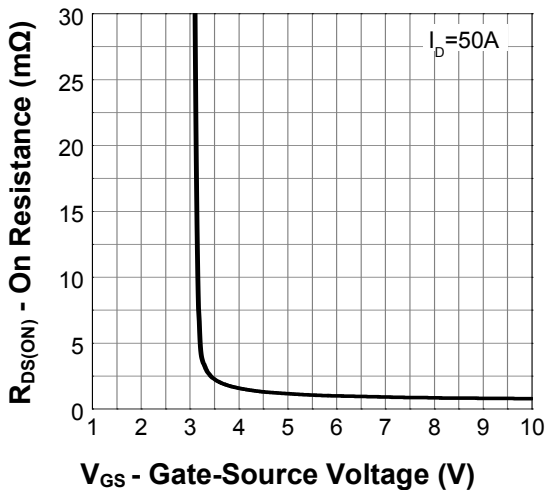

Gate Charge

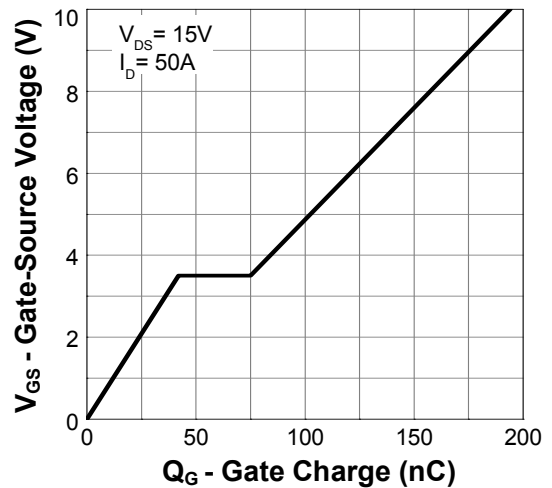

Power Capability

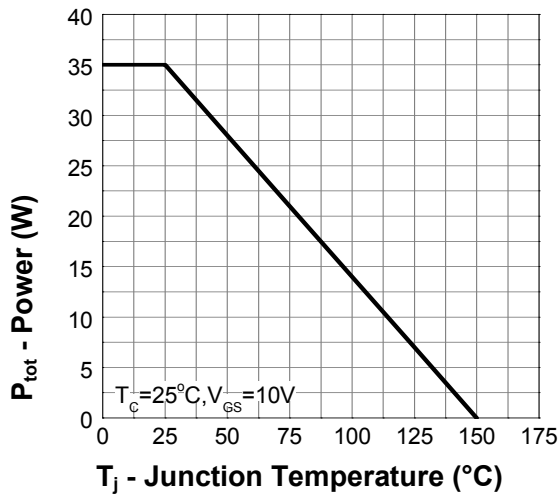

Current Capability

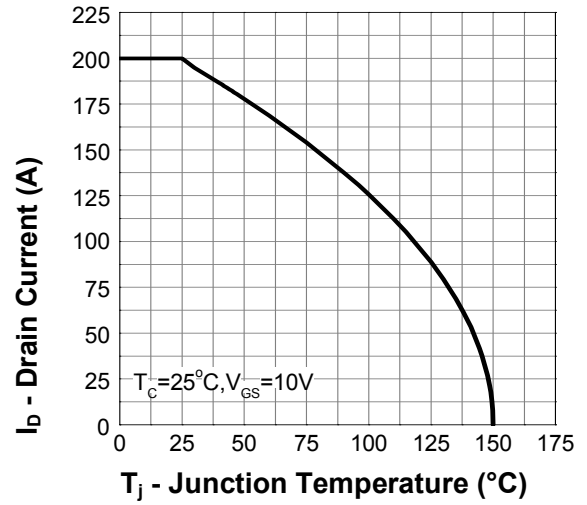

Safe Operation Area

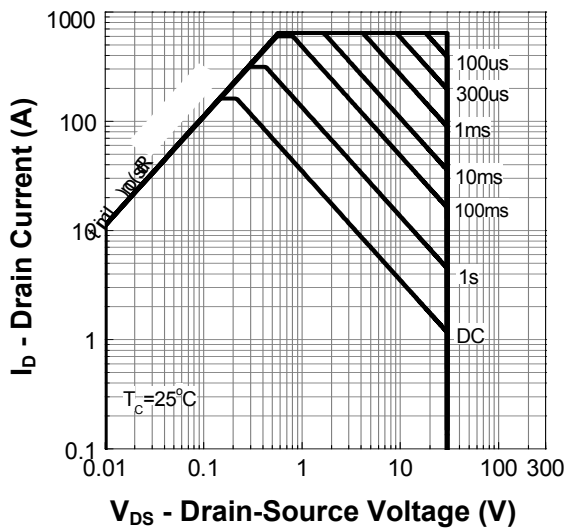

Transient Thermal Impedance

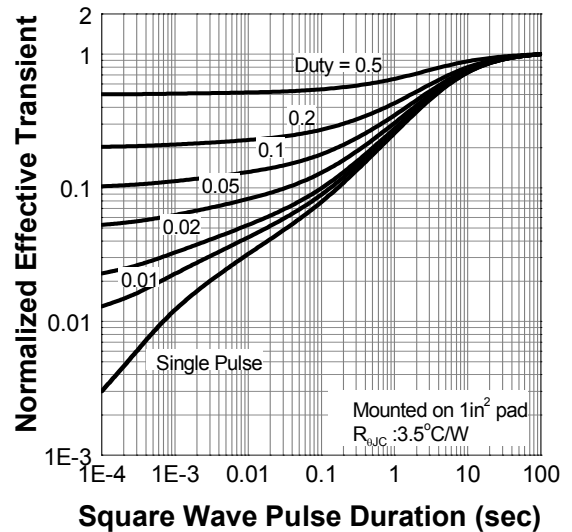

DFN5X6-8L Package Outline Dimensions

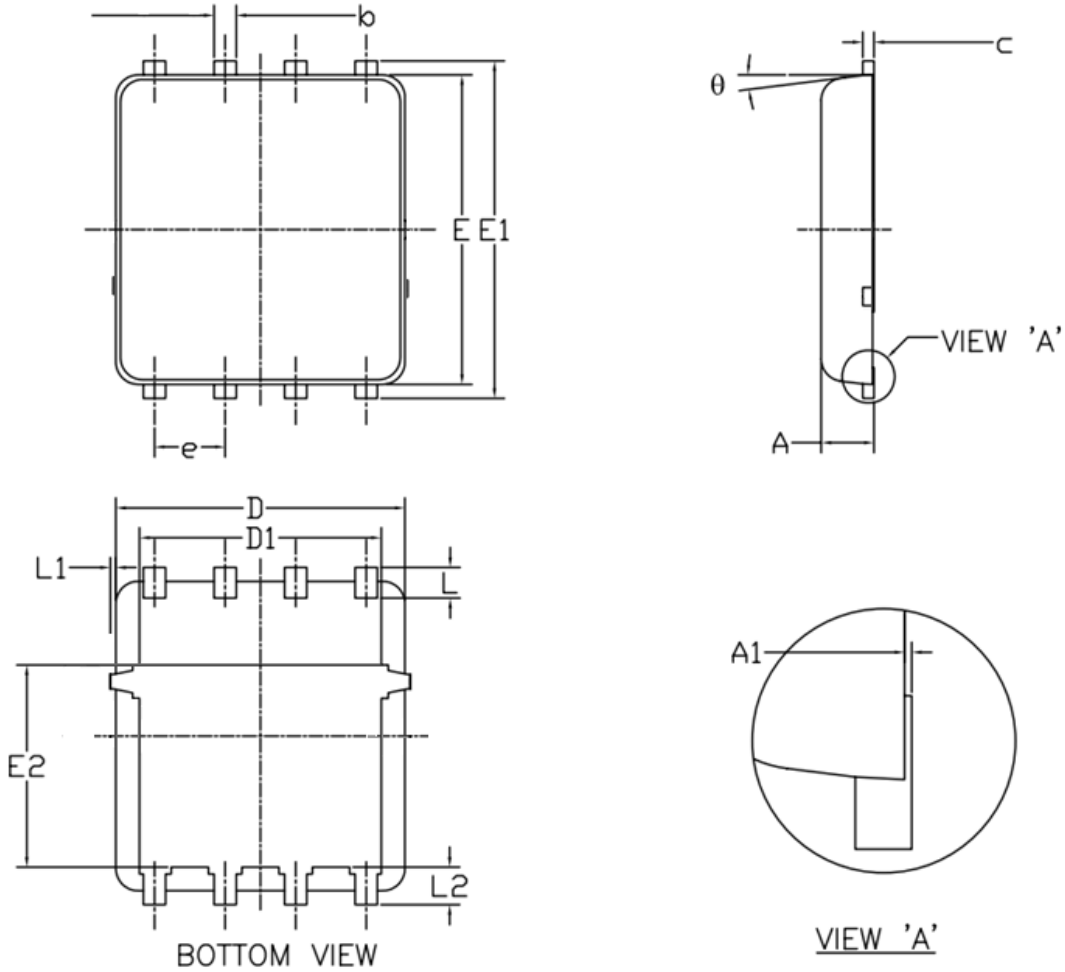

Symbol	Dimensions (unit:mm)			Symbol	Dimensions (unit:mm)		
	Min	Typ	Max		Min	Typ	Max
A	0.90	1.00	1.20	E1	5.90	6.10	6.35
A1	0.00	--	0.05	E2	3.38	3.58	3.92
b	0.30	0.40	0.51	e	1.27 BSC		
c	0.20	0.25	0.33	L	0.51	0.61	0.71
D	4.80	4.90	5.40	L1	--	--	0.15
D1	3.61	4.00	4.25	L2	0.41	0.51	0.61
E	5.65	5.80	6.06	θ	0°	--	12°

Printing Information

ATC =====Brand

XXXXXXXX =====Material Code

XXYY =====XX Representative Year
 YY Representative Weeks